



IRINOX

U S E A N D
M A I N T E N A N C E
I N S T R U C T I O N S

MultiFresh[®] MF

N°REV	REVISION DESCRIPTION	REV. DATE	REVISER
01	REGULATORY UPDATE	02/05/2014	R.R.
02	CORRECTIONS AND LAYOUT UPDATE	27/08/2015	L.B.
03	ADDED GAS R452A	10/09/2017	D.N.

Dear Customer,

Thank you for having chosen IRINOX.

Please take the time to read this manual carefully to make the most of all the potential and benefits of your new MULTIFRESH.

We would like to remind you that the perfect operation of the machine also depends on its correct use.

Keep this manual close to the MULTIFRESH so that it can be consulted easily by you and anyone else.

The graphic representations of the controls in the manual have been designed to make the machine easy and intuitive to use.

Symbols key



suggestions and details for correct use of the blast chiller



standards for your safety



additional information in this manual

Information regarding the warranty and assistance

Warranty validity: of the individual parts for 12 months from the date of invoicing, as stated in the price list in force.

Contacts:

Customer service	+39.0438.5844
User assistance	+39.0438.5844
Technical - spare parts after-sales	+39.0438.2020
Fax	+39.0438.2023
E-mail	service@irinox.com
Web site	www.irinoxprofessional.com

For every request relative to your blast chiller, always indicate:

- The model
- The serial number

stated on the label on the model

SAFETY INFORMATION



Below find the main general Safety Standards:

- Do not touch or operate the machine with damp or wet feet and hands.
- do not insert screwdrivers, kitchen tools or other between the protections and the moving parts.
- before carrying out cleaning operations or routine maintenance, disconnect the machine from the power supply mains, switching the master switch off and removing the plug.
- do not pull the power supply cable to disconnect the machine from the power supply mains.



If the power supply cable is damaged, it must be replaced by the manufacturer, service centre or similarly qualified staff, in order to avoid risks.

Non-mobile equipment, not equipped with disconnection devices from the power supply having a contact separation of all poles that provide disconnection in category III overvoltage conditions; must be equipped with a disconnection device incorporated in the fixed connection in compliance with the connection regulations.



Use gloves suitable for trays and cold trolleys.



Do not overload the machine beyond that established by the manufacturer (Trays capacity and Yield Tab.).



Do not block the ventilation openings of the unit and of the structure in which it is positioned.



When loading the machine, the use of kitchen gloves is recommended in order to prevent burns on contact with the hot trays and trolleys.



During cleaning operations, of the condenser in particular, always wear protective gloves, safety glasses and mask for the respiratory protection.



The core probe must only be used for the purpose for which it has been designed: detect the temperature at the centre of the food stuffs to be blast chilled and/or frozen.



It is prohibited to remove the protections and safety devices in order to perform routine maintenance.



Climatic Class:

4 (environment temperature 30°C with relative humidity 55% non condensing) according to IEC EN 60335-1, IEC EN 60335-2-89, ISO23953-2:2005 (E) Standards



Do not store explosive substances, such as aerosol spray cans with inflammable propellant inside the equipment.



- Do not use mechanical or similar devices to speed up the thawing process other than those recommended by the manufacturer.
- Do not damage the refrigerant circuit.
- Do not use inside the unit any electrical device unless it is of the type and/or model recommended by the manufacturer.
- Do not use water jets to clean the unit.
- The unit can be used by children over 8 years and by people with reduced physical, sensory or mental capabilities, or lack of experience or knowledge, provided under supervision or after that the latter have received instructions relating to the safe use of the unit and understanding of the dangers inherent in it. Children must not play with the unit. Cleaning and maintenance intended to be performed by the user must not be performed by unsupervised children.

MODELS	Yields	
	Blast chilling (Kg)	Freezing (Kg)
MF25.1	25	25
MF45.1	45	45
MF70.1	70	70
MF30.2	30	30
MF70.2	70	70
MF85.2	85	85

The yields are declared in the following conditions:

- Trays filled with water at 90°C
- Environment temperature: 32°C
- No chamber pre-cooling

MODELS	CATERING						CONFECTIONERY		
	GN 1/1 h=20	GN 1/1 h=40	GN 1/1 h=65	GN 2/1 h=20	GN 2/1 h=40	GN 2/1 h=65	400x600 h=20	400x600 h=40	400x600 h=60
MF25.1	8	5	4				8	5	4
MF45.1	18	12	9				18	12	9
MF70.1	27	18	13				27	18	13
MF30.2	16	10	8	8	5	4	8*	5*	4*
MF70.2	36	24	18	18	12	9	18*	12*	9*
MF85.2	54	36	26	27	18	13	27*	18*	13*

(*) tray to rested on 530x650mm grill

INDEX

1. GENERAL DOCUMENTATION	5
1.1 GENERAL RECOMMENDATIONS	5
1.2 FOREWORD	5
1.3 TRANSPORT AND HANDLING	5
1.4 UNPACKING	5
1.5 ELEMENTARY SAFETY STANDARDS	6
1.6 PRECAUTIONS FOR LOADING OR UNLOADING	6
1.7 DANGEROUS USE OF THE POINTED PROBE	6
1.8 PERIODICAL STAFF TRAINING	6
2. INSTALLATION	7
2.1 PLATE DATA	7
2.2 POSITIONING	7
2.3 DIMENSIONAL DATA	8
2.4 ENVIRONMENT TEMPERATURES AND AIR EXCHANGE	11
2.5 COOLING CAPACITIES	11
2.6 ELECTRIC CONNECTION	11
2.7 REFRIGERATOR CONNECTION	14
2.8 CONDENSATE DRAIN	15
2.9 WATER COOLING UNITS CONNECTION	16
2.10 NOTES FOR THE INSTALLER	16
2.11 SAFETY AND CONTROL SYSTEMS	17
2.12 DISPOSING OF THE MACHINE	17
2.13 GAS R404A / R452A GAS SAFETY SHEET	18
3. OPERATION	19
3.1 USE	19
3.2 DESCRIPTION OF CYCLES	19
3.3 DESCRIPTION AND OPERATION	24
3.3.1 PRELIMINARY OPERATIONS	24
3.3.1.1 INITIAL START-UP	24
3.3.1.2 HEATING	25
3.3.2 SELECTING THE CYCLES	25
3.3.2.1 AUTOMATIC MODE	26
3.3.2.2 MANUAL MODE	27
3.3.2.3 FAVOURITES	28
3.3.2.4 DEFROST	28
3.3.2.5 COOLING AND FREEZING	29
3.3.2.6 THAWING	30
3.3.2.7 COOKING AT LOW HEAT	31
3.3.2.8 PROOFING	32
3.3.2.9 PASTEURISATION	32
3.3.3 FUNCTIONS	33
3.3.3.1 CONTINUOUS CYCLE	33
3.3.3.2 TURNING OUT	35
3.3.3.3 CORE PROBE TEMPERATURE INDICATION	35
3.3.3.4 ENTERING CYCLES IN THE FAVOURITES AREA	36
3.3.3.5 RECORDING CYCLES	37
3.3.2.6 DISABLING THE KEYBOARD	38
3.4 STOPPING MODES	38
3.5 RECOMMENDATIONS FOR USE	39
3.6 PROGRAMMING THE PARAMETERS	41
3.6.1 CONFIGURING THE OPERATOR PARAMETERS	41
3.6.2 MODIFYING THE CYCLE PARAMETERS	42
3.7 SANIGEN	43
4. MAINTENANCE / SERVICE	47
4.1 ROUTINE MAINTENANCE	47
4.2 CLEANING THE CHAMBER	47
4.3 CLEANING THE CONDENSER	48
4.4 TROUBLE SHOOTING	49
4.5 EXTRAORDINARY MAINTENANCE	51

1. GENERAL DOCUMENTATION

1.1. GENERAL RECOMMENDATIONS

- This manual is an integral part of the product, it supplies all of the indications necessary for correct installation, correct use and maintenance of the machine.
- It is mandatory for the user to read this manual carefully and always make reference to it. Moreover, it must be kept in place that is known and accessible to the authorised operators (installer, user, maintenance technician)
- The blast chiller is intended for professional use and therefore only qualified staff can use it
- The blast chiller is destined only for the use for which it has been designed.
- The Blast Chiller shall not be installed and utilized in an explosive environment (presence of explosive powder or gas)
- The manufacturer declines all responsibility for any damage caused by incorrect or unreasonable use, as for example:
 - improper use by untrained staff.
 - modification or interventions that are not specific for the model.
 - use of non-original spare parts or that are not specific for the model.
 - failure to comply, even partial, with the instructions in this manual.
- The Manufacturer disclaims all responsibility for problems related to an incorrect installation of the blast chiller.
For machines supplied with remote condensing unit, the manufacturer responsibility is limited to the inlet and outlet valves of the supplied machines

1.2 FOREWORD

Installation must be carried out by authorised and specialised staff, respecting the instructions in this manual. The manufacturer declares and assigns a Declaration of Conformity to the 2006/42, Machinery Directive, to the 2014/35/UE Directive and to the 2014/30/UE. Directive to each individual machine.

In compliance with directive 97/23/EC, based on the model the equipment is supplied together with the user manuals and declarations of conformity of the:

- safety valve;
- liquid receiver;
- liquid separator;
- liquid receiver + separator;
- compressors

- oil separator;
 - safety pressure switches.
- The joints made by IRINOX S.p.a. comply with the standard EN14276-2

Whenever the machine is supplied with the remote condensing unit, it is the installer's responsibility to check all connections and issue a declaration of perfect execution and is in compliance with the provisions of the above-mentioned Directive.

The joints made by IRINOX S.p.a. comply with the standard EN14276-2.

IMPORTANT NOTE: IRINOX reminds you that all the machines must undergo periodical inspections in compliance with national standards in force.

1.3 TRANSPORT AND HANDLING

- The loading and unloading of the appliance from the means of transport can be performed using a fork lift truck or transpallets with forks that have a length exceeding half of the length of the object. The lifting means must be adequately selected on the basis of the dimensions and weight of the packaged machine, indicated on the labels of the packaging.
- All necessary precautions must be adopted when handling the appliance in order not to damage it, respecting the indications positioned on the packaging.

1.4. UNPACKING

- Remove the cardboard or wooden packaging or crate from the wooden base on which the blast chiller is rested. Lift the blast chiller using suitable means (fork lift truck), remove the wooden base and position the machine in the envisioned place (see par. 2.2).
- After the packaging has been removed, check the integrity of the blast chiller.
- Remove the protective PVC film from all sides (Fig.1).



When handling the packaging and the wooden base, use protective gloves.

N.B.: all of the various packaging components must be disposed of according to the Standards in force in the Country where the appliance is used. In all cases, nothing must be dispersed into the environment.

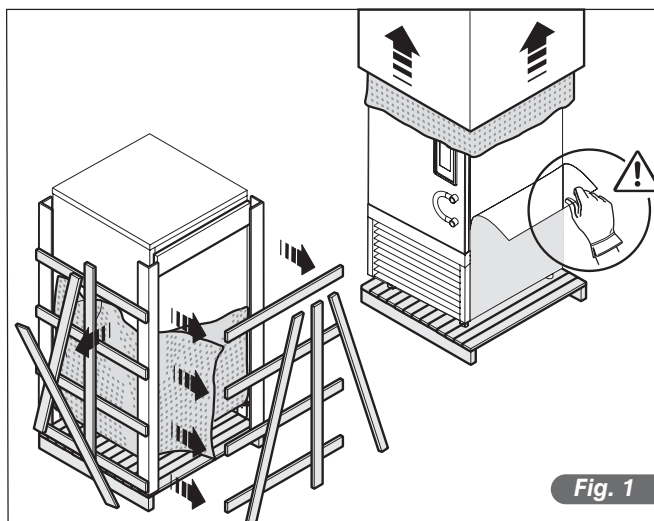

Fig. 1

1.5. ELEMENTARY SAFETY STANDARDS

The responsibility of the operations performed on the machine, ignoring the indications stated in this manual, is implemented by the user.

Below find the main general Safety Standards:

- do not touch the machine with humid or wet hands and feet
- do not operate the machine with bare feet
- do not insert screwdrivers, kitchen tools or other

between the protections and the moving parts.

- before carrying out cleaning operations or routine maintenance, disconnect the machine from the power supply mains, switching the master switch off and removing the plug.
- do not pull the power supply cable to disconnect the machine from the power supply mains.

1.6. PRECAUTIONS FOR LOADING OR UNLOADING

LOADING

- When loading the machine, the use of kitchen gloves is recommended in order to prevent burns on contact with the hot trays and trolleys.

UNLOADING

- When the blast chilling and/or freezing cycle is terminated, open the door slowly until the fans stop.
- Extract the product core probe/s and position it/them on the probe/holder.
- Use gloves suitable for trays and cold trolleys.

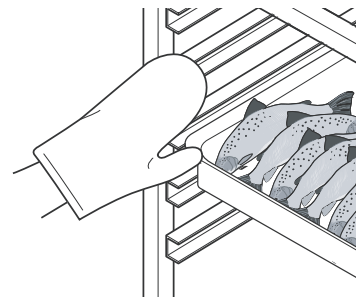

1.7. DANGEROUS USE OF THE POINTED PROBE

Use of the probe is only allowed by authorised staff, trained regarding use of the blast chiller.

The core probe must only be used for the purpose for which it has been designed: to detect the temperature at the centre of the food stuffs to be blast chilled and/or frozen.

Handle the probe with care. Its end is pointed to make insertion into the product to be blast chilled and/or frozen easier.

The ergonomic grip allows correct extraction and insertion.

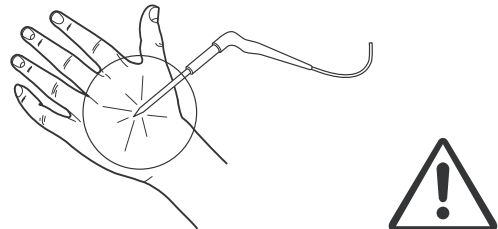

1.8. PERIODICAL STAFF TRAINING

It is recommended to carry out periodical training of all staff, which is authorised to operate on the machine, regarding Safety Standards (installer, user, maintenance technician).

To prevent accidents or damage to the equipment, it is also recommended to periodically train staff regarding use and maintenance of the temperature blast chiller, making reference to this manual, which must be kept near to the machine, in a known and accessible place.



2. INSTALLATION

2.1. PLATE DATA

- Check that the plate data and the characteristics of the electric line correspond (V, kW, Hz, n° phases and power available)
- The plate with the appliance features is applied on the side (fig.2).

The eventual preparation of machine rooms for positioning the condensing units must follow the Standards in force in the country of installation regarding fire-prevention (contact the local fire department for the due indications).

i It must also be considered that any intervention of the safety valve or fuse caps, currently in the refrigerator circuit, leads to the immediate discharge of all refrigerant used in the environment. Consequently, realise appropriate means of disposal and first aid as indicated in the refrigerant safety sheet (►see par. 2.12).

Climatic Class:

- **4** (environment temperature 30°C with relative humidity 55% non condensing) according to IEC EN 60335-1, IEC EN 60335-2-89, ISO 23953-2:2005 (E) Standards

IRINOX		31020 CORBANESE (TV) ITALY
Mod.	[Redacted]	
s/n	[Redacted]	
[Redacted]	V	Ph
[Redacted]	A	Kw
HERMETIC Compressor	[Redacted]	
Refrigerant R404/R452A	Charge	
Design pressure (Low)	KPa	
Design pressure (High)	KPa	
Class	Volume	
Rated Load	[Redacted]	
IP	[Redacted]	
PED Code	[Redacted]	
	CE	

Model
Serial N°
mm/yy/progres.
Frequency
Power
Phase
Volt
Absorption

Fig. 2

2.2. POSITIONING

- The blast chiller must be installed and inspected with complete respect of the accident-prevention legal Standards, traditional regulations and Standards in force.
- The installer must check any provisions on the subject of fire-prevention (contact the local fire department for the due indications).
- Place the blast chiller in the place envisioned.
- Position the blast chiller on the floor.
- Level the appliance using the adjustable feet. Use the relative lifting devices to level heavier machines (Fig.3).
- If the appliances are not levelled, their functioning and the flow of condensate can be compromised.

To avoid (Fig.4):

- Places exposed to direct sunlight
- Closed places with high temperatures and low air exchange (►see **Table 2**).
- Do not install the machine near to any heat source.

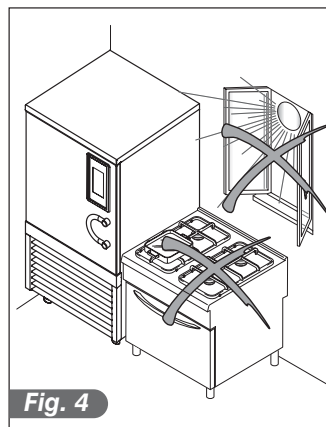
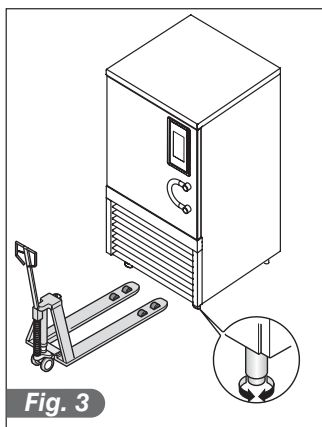

- The remote units are manufactured to be installed in places protected against adverse weather conditions. The plants must be positioned on a levelled cement or steel base and must have the maintenance space according to the technical files. If installed on the roof or attic, beams should be provided which divide the weight. Furthermore the base must be sufficiently sturdy and capable of bearing the weight of the complete unit resulting from the technical data of the specific drawing. To avoid further vibrations or noise, it is recommended to use neoprene anti-vibration pads underneath the corners of the unit's base.
- If the blast chiller/conservator is installed below floor level or underground, the installer must apply the clauses foreseen by the standard EN378-1:2008 + A1:2010 ANNEX D to guarantee that no one can remain locked inside the cell at the end of the work shift.
- The blast chiller/conservator can be installed underground or on a loft as long as there are adequate emergency exits as foreseen by the standard EN378-1:2008+A1:2010 ANNEX C.
- The installer must verify the need for forced ventilation inside a room where the blast chiller/conservator is installed as foreseen by the standard EN378-2:2008+A1:2009 chapter 6.2.14.



Do not block the ventilation openings of the unit and of the structure in which it is positioned.

2.3. DIMENSIONAL DATA

FRONT VIEW

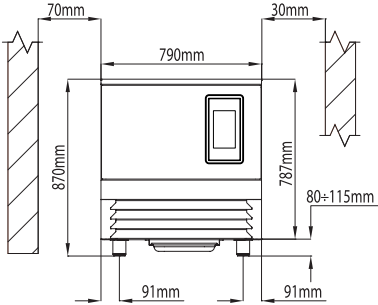

SIDE VIEW

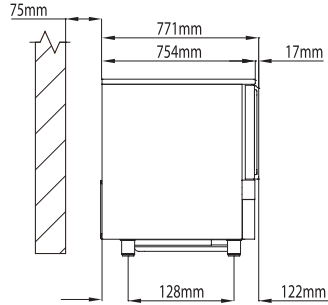

UPPER VIEW

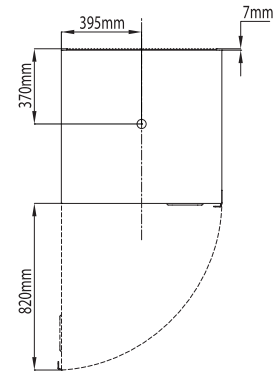

MF20.1

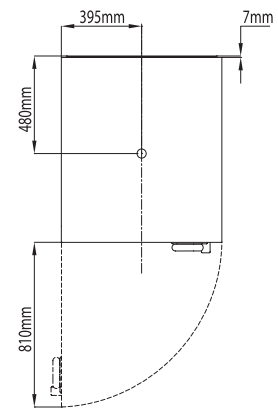
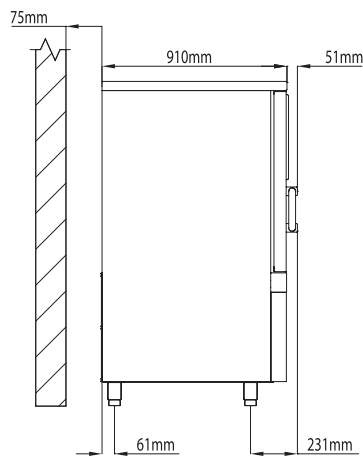
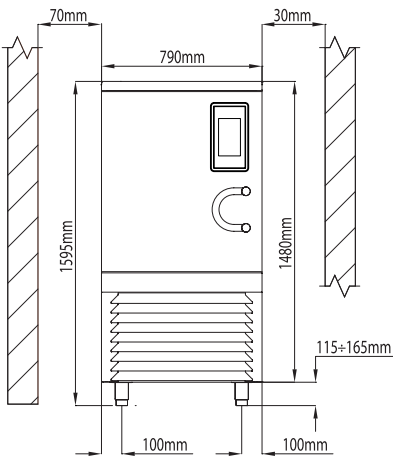

MF45.1

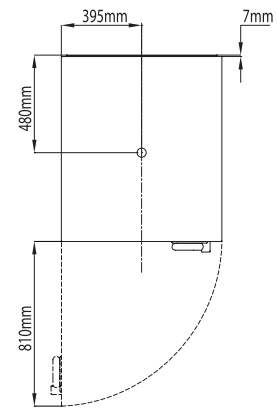
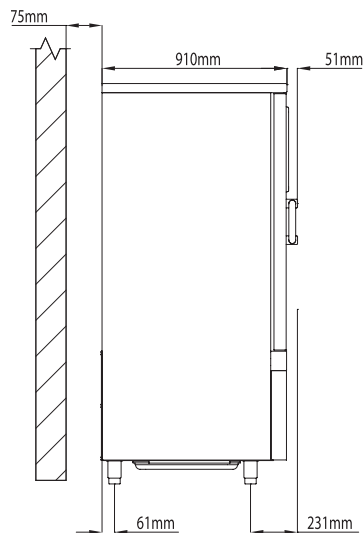
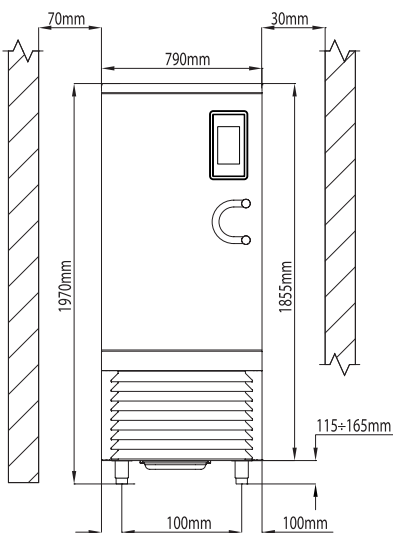

MF70.1

2.3. DIMENSIONAL DATA

FRONT VIEW

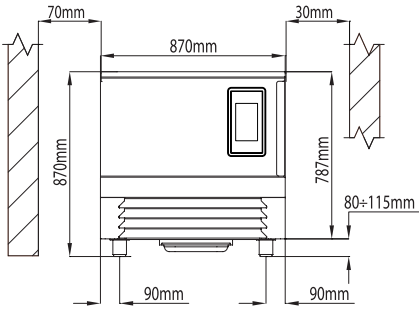

SIDE VIEW

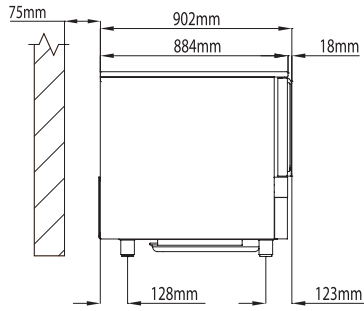

UPPER VIEW

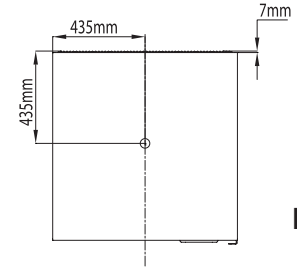

MF30.2

FRONT VIEW

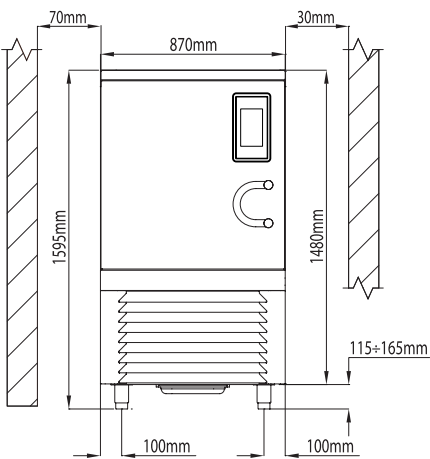

SIDE VIEW

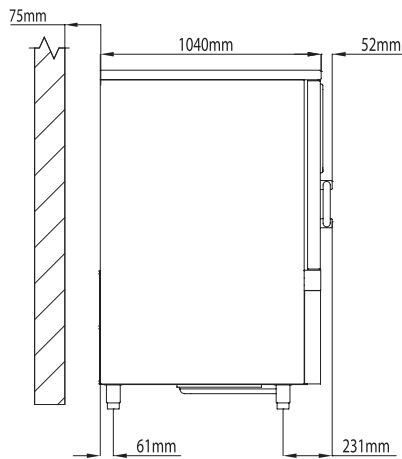

UPPER VIEW

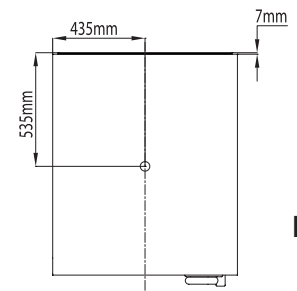

MF70.2

FRONT VIEW

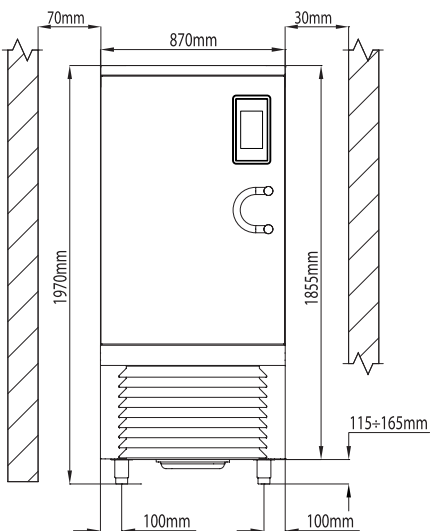

SIDE VIEW

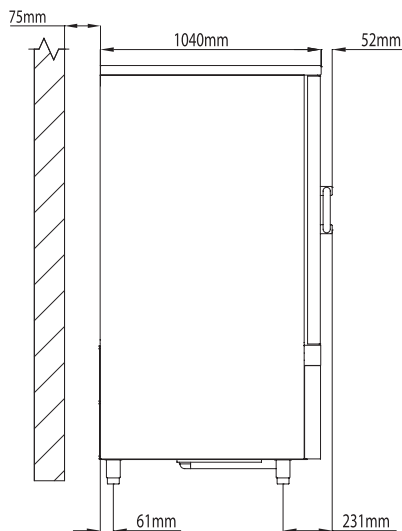

UPPER VIEW

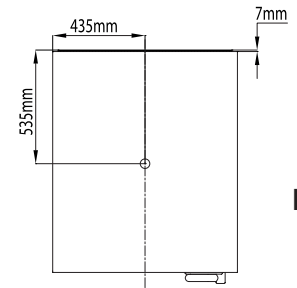

MF85.2

2.3. DIMENSIONAL DATA

MF45.1 condensing unit

MF45.1 condensing unit

MF70.1 / MF70.2 / MF85.2 condensing unit

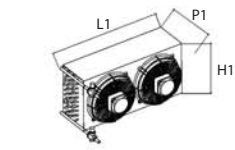

Remote condenser

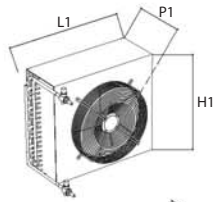

Super silenced remote condenser

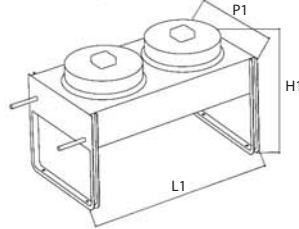

Air cooled remote unit

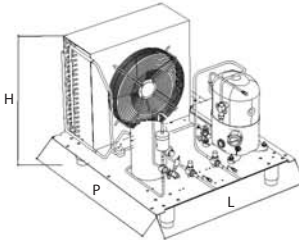

Remote unit and remote air condenser

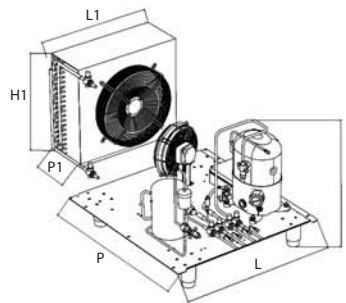

Remote unit and super silenced remote air condenser

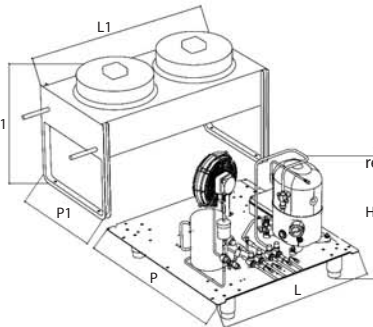

Case option

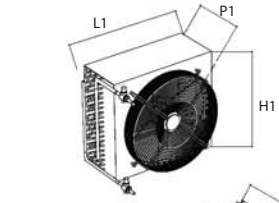
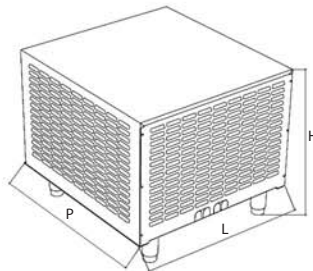
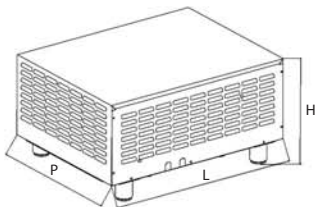

Remote condenser

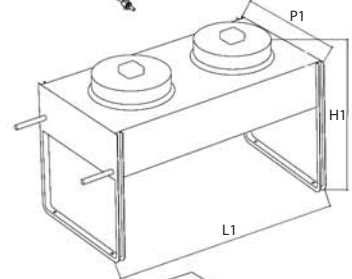

Super silenced remote condenser

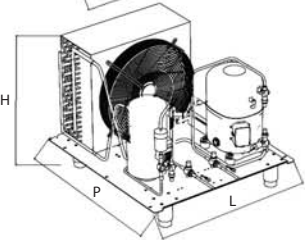

Air cooled remote unit

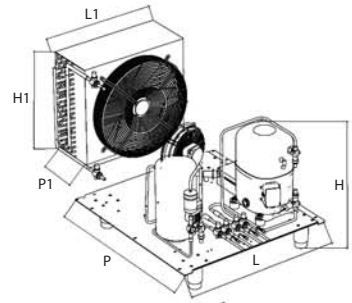

Remote unit and remote air condenser

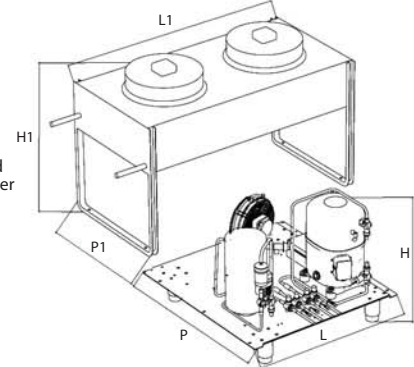

Remote unit and super silenced remote air condenser

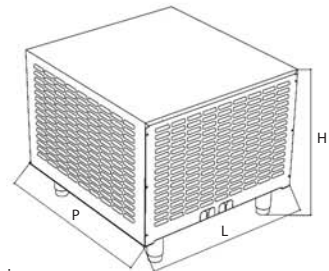

Case option

Remote condensing unit dimensions.

MOD.	MF25.1		MF45.1		MF70.1		MF30.2		MF70.2		MF85.2	
	AIR	CASED	AIR	REMOTE COND	AIR	REMOTE COND	AIR	CASED	AIR	REMOTE COND	AIR	CASED
L	78	78	79	79	80	78	78	79	79	80	79	80
P	62	63	84	84	85	84	84	85	62	63	84	84
H	37	41	64	56	67	64	56	67	38	41	64	56
Kg	40.5	51	85	64	103.5	93	72	111.5	40.5	51	85	64

Remote condenser dimensions.

MOD.	MF25.1		MF45.1		MF70.1		MF30.2		MF70.2		MF85.2	
	STD.AIR	STD.AIR	SUPER SIL.AIR	STD.AIR	SUPER SIL.AIR	STD.AIR	STD.AIR	SUPER SIL.AIR	ARIA STD.	SUPER SIL.AIR		
L1	59	58	89	59	111	59	58	111	58	167		
P1	27	31	50	33	60	27	40	60	40	60		
H1	29	51	60	51	75	29	51	75	51	75		
Kg	5.6	13	23	21	33	5.6	21	33	21	41		

2.4. ENVIRONMENT TEMPERATURES AND AIR EXCHANGE

For air-cooled chiller units, the temperature of the functioning environment must not exceed 32 °C. The performance declared is not guaranteed over this temperature.

The remote condensing units must be installed in opposite rooms or outdoors, in a place protected from direct sunlight. If the circumstances should make it necessary, the installer must evaluate whether the use of a cover or roof is required (in all cases sufficient air exchange must be guaranteed).

i For further details ► see **Table 2**.

Table 2

MINIMUM AIR EXCHANGE MODEL		
CHAMBER	Power supply frequency (Hz)	AIR (m ³ /h)
MF25.1	50	1100
	60	1210
MF45.1	50	3000
	60	3300
MF70.1	50	4000
	60	4400
MF30.2	50	1100
	60	1210
MF70.2	50	4000
	60	4400
MF85.2	50	4000
	60	4400

2.5. COOLING CAPACITIES

Table 3

CHAMBER	Power supply frequency (Hz)	Cooling efficiency (W)	Condensing power (W)
MF25.1	50	1727	2683
	60	1623	2549
MF45.1	50	6013	9075
	60	7216	11038
MF70.1	50	8851	13053
	60	10305	15548
MF30.2	50	2427	3712
	60	2591	4012
MF70.2	50	8851	13053
	60	10305	15548
MF85.2	50	10853	15842
	60	12776	19225

Values declared at T.evap.=-10°C, T.cond.=+40°C and power supply f.=50Hz.
Over-heating in compliance with EN12900

2.6. ELECTRIC CONNECTION

Install an automatic differential magnet-circuit breaker switch upstream from every appliance, according to the Standards in force in the country of installation.

The size of the connection cables must comply with the information contained in the electric data of the technical files. The voltage of the plants must be within the limit of +10% and voltage unbalance of the phases must not exceed 3%. The electric power connection must be carried out by qualified personnel, in compliance with the directives and laws of the country where the unit is installed.

The power supply must be taken to the blast chiller electric control board, according to the data given in **Table 4**.

- The electric power supply cables must be correctly dimensioned and selected depending on the real laying conditions;
- The electric cables must be introduced and blocked in the relevant fairlead and placed in a suitable manner depending on the place of installation;
- Every wire must be inserted into the corresponding clamp;
- The earth wire must be correctly connected to an efficient earth plant.

! *The manufacturer declines all liability and every warranty obligation, whenever the appliance or objects are damaged and persons are injured due to incorrect installation and/or failure to comply with the laws in force.*

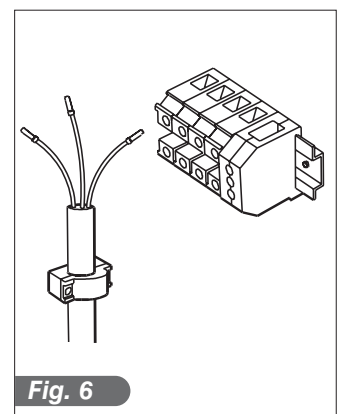
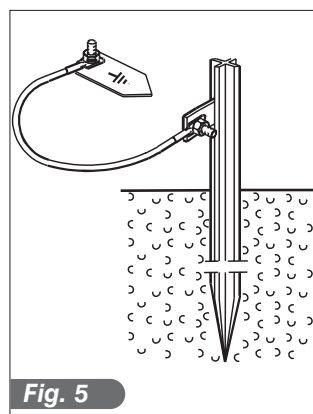

Table 4

CHAMBER	CONDENSING UNIT	POWER SUPPLY			ABSORPTION		POWER SUPPLY CABLE SECTION *1	CABLE SECTIONS FOR REMOTE CONDENSING UNITS *2		
		Voltage (V)	Frequency (Hz)	Poles	Power (kW)	Current (A)				
MF25.1	Air	230	50	1P+N+PE	1,2	6,5	3G2,5mmq	3G2,5mmq + 3x1,5mmq		
		230	60	1P+N+PE	1,3	6,3				
		200/208	50	2P+PE	1,3	6,5				
		200/208	60	2P+PE	1,3	6,4				
	Air remote condenser	230	50	1P+N+PE	1,3	6,9				
		230	60	1P+N+PE	1,3	6,6				
		200/208	50	2P+PE	1,3	6,8				
		200/208	60	2P+PE	1,3	6,7				
	Water	230	50	1P+N+PE	1,1	6,1				
		230	60	1P+N+PE	1,2	5,9				
		200/208	50	2P+PE	1,2	6,1				
		200/208	60	2P+PE	1,2	6,1				
MF45.1	Air	400	50	3P+N+PE	3,6	5,6	5G2,5mmq	4G2,5mmq + 10x1,5mmq		
		400	60	3P+N+PE	3,7	5,9				
		230	50	3P+PE	3,8	14,3			4G2,5mmq	4G4mmq + 10x1,5mmq
		230	60	3P+PE	4,5	14,6				
		200/208	50	3P+PE	4,5	12,6				
		200/208	60	3P+PE	4,5	12,6				
	Air remote condenser	400	50	3P+N+PE	3,7	5,6	5G2,5mmq	4G2,5mmq + 10x1,5mmq		
		400	60	3P+N+PE	3,8	6,0				
		230	50	3P+PE	3,8	14,6			4G2,5mmq	4G4mmq + 10x1,5mmq
		230	60	3P+PE	4,6	14,8				
		200/208	50	3P+PE	4,5	12,8				
		200/208	60	3P+PE	4,5	12,8				
	Super Silenced Air remote condenser	400	50	3P+N+PE	3,7	5,7	5G2,5mmq	4G2,5mmq + 10x1,5mmq		
		400	60	3P+N+PE	3,8	6,0				
		230	50	3P+PE	3,8	14,6			4G2,5mmq	4G4mmq + 10x1,5mmq
		230	60	3P+PE	4,6	14,8				
		200/208	50	3P+PE	4,5	12,8				
		200/208	60	3P+PE	4,5	12,8				
	Water	400	50	3P+N+PE	3,6	5,5	5G2,5mmq	4G2,5mmq + 10x1,5mmq		
		400	60	3P+N+PE	3,6	5,7				
		230	50	3P+PE	3,7	14,3			4G2,5mmq	4G4mmq + 10x1,5mmq
		230	60	3P+PE	4,4	14,4				
		200/208	50	3P+PE	4,4	12,5				
		200/208	60	3P+PE	4,4	12,5				
MF70.1	Air	400	50	3P+N+PE	5,3	10,8	5G2,5mmq	4G2,5mmq + 10x1,5mmq		
		400	60	3P+N+PE	5,4	11,6				
		230	50	3P+PE	5,3	26,2			4G4mmq	4G6mmq + 10x1,5mmq
		230	60	3P+PE	6,6	26,3				
		200/208	50	3P+PE	5,7	26,7				
		200/208	60	3P+PE	6,7	26,8				
	Air remote condenser	400	50	3P+N+PE	5,4	10,8	5G2,5mmq	4G2,5mmq + 10x1,5mmq		
		400	60	3P+N+PE	5,5	11,7				
		230	50	3P+PE	5,3	26,5			4G4mmq	4G6mmq + 10x1,5mmq
		230	60	3P+PE	6,6	26,5				
		200/208	50	3P+PE	5,6	26,9				
		200/208	60	3P+PE	6,8	27,0				
	Super Silenced Air remote condenser	400	50	3P+N+PE	5,3	10,8	5G2,5mmq	4G2,5mmq + 10x1,5mmq		
		400	60	3P+N+PE	5,3	11,6				
		230	50	3P+PE	5,2	26,4			4G4mmq	4G6mmq + 10x1,5mmq
		230	60	3P+PE	6,5	26,3				
		200/208	50	3P+PE	5,1	26,0				
		200/208	60	3P+PE	6,3	25,9				
	Water	400	50	3P+N+PE	5,1	10,6	5G2,5mmq	4G2,5mmq + 10x1,5mmq		
		400	60	3P+N+PE	5,1	11,4				
		230	50	3P+PE	5,1	26,0			4G4mmq	4G6mmq + 10x1,5mmq
		230	60	3P+PE	6,3	25,9				
		200/208	50	3P+PE	5,1	26,0				
		200/208	60	3P+PE	6,3	25,9				

NOTES: *1 cable dimensioned for a length of 6m;

*2 cable dimensioned for a length 25m.

Industrial voltage drop V% 1%; H07 RN-F type cable

Table 4

CHAMBER	CONDENSING UNIT	POWER SUPPLY			ABSORPTION		POWER SUPPLY CABLE SECTION *1	CABLE SECTIONS FOR REMOTE CONDENSING UNITS *2
		Voltage (V)	Frequency (Hz)	Poles	Power (kW)	Current (A)		
MF30.2	Air	230	50	1P+N+PE	1,6	7,1	3G2,5mmq	3G4mmq + 3x1,5mmq
		230	60	1P+N+PE	1,8	11,5		
		200/208	50	2P+PE	1,9	11,6		
		200/208	60	2P+PE	1,8	11,5		
	Air remote condenser	230	50	1P+N+PE	1,7	7,4		3G4mmq + 3x1,5mmq
		230	60	1P+N+PE	1,9	11,8		
		200/208	50	2P+PE	1,9	12,0		3G6mmq + 3x1,5mmq
		200/208	60	2P+PE	1,9	11,9		
	Water	230	50	1P+N+PE	1,5	6,8		3G4mmq + 3x1,5mmq
		230	60	1P+N+PE	1,8	11,1		
		200/208	50	2P+PE	1,8	11,2		3G6mmq + 3x1,5mmq
		200/208	60	2P+PE	1,8	11,1		
MF70.2	Air	400	50	3P+N+PE	5,2	10,6	5G2,5mmq	4G2,5mmq + 10x1,5mmq
		400	60	3P+N+PE	5,3	11,4		
		230	50	3P+PE	5,2	25,9	4G4mmq	4G6mmq + 10x1,5mmq
		230	60	3P+PE	6,5	25,9		
		200/208	50	3P+PE	5,4	26,3		
		200/208	60	3P+PE	6,6	26,5		
	Air remote condenser	400	50	3P+N+PE	5,3	10,7	5G2,5mmq	4G2,5mmq + 10x1,5mmq
		400	60	3P+N+PE	5,4	11,5		
		230	50	3P+PE	5,2	26,1	4G4mmq	4G6mmq + 10x1,5mmq
		230	60	3P+PE	6,5	26,1		
		200/208	50	3P+PE	5,5	26,6		
		200/208	60	3P+PE	6,7	26,7		
	Super Silenced Air remote condenser	400	50	3P+N+PE	5,2	10,6	5G2,5mmq	4G2,5mmq + 10x1,5mmq
		400	60	3P+N+PE	5,2	11,4		
		230	50	3P+PE	5,1	26,0	4G4mmq	4G6mmq + 10x1,5mmq
		230	60	3P+PE	6,4	26,0		
		200/208	50	3P+PE	5,0	25,7		
		200/208	60	3P+PE	6,2	25,6		
	Water	400	50	3P+N+PE	5,0	10,4	5G2,5mmq	4G2,5mmq + 10x1,5mmq
		400	60	3P+N+PE	5,0	11,2		
		230	50	3P+PE	5,0	25,7	4G4mmq	4G6mmq + 10x1,5mmq
		230	60	3P+PE	6,2	25,6		
		200/208	50	3P+PE	5,0	25,8		
		200/208	60	3P+PE	6,2	25,6		
MF85.2	Air	400	50	3P+N+PE	6,2	13,5	5G2,5mmq	4G2,5mmq + 10x1,5mmq
		400	60	3P+N+PE	7,8	15,0		
		230	50	3P+PE	6,0	31,0	4G6mmq	4G6mmq + 10x1,5mmq
		230	60	3P+PE	7,9	32,5		
		200/208	50	3P+PE	6,3	31,5	4G10mmq	4G10mmq + 10x1,5mmq
		200/208	60	3P+PE	8,0	33,1		
	Air remote condenser	400	50	3P+N+PE	6,2	13,6	5G2,5mmq	4G2,5mmq + 10x1,5mmq
		400	60	3P+N+PE	7,9	15,1		
		230	50	3P+PE	6,1	31,3	4G6mmq	4G6mmq + 10x1,5mmq
		230	60	3P+PE	7,9	32,8		
		200/208	50	3P+PE	6,3	31,7	4G10mmq	4G10mmq + 10x1,5mmq
		200/208	60	3P+PE	8,1	33,3		
	Super Silenced Air remote condenser	400	50	3P+N+PE	6,2	13,6	5G2,5mmq	4G2,5mmq + 10x1,5mmq
		400	60	3P+N+PE	7,8	15,2		
		230	50	3P+PE	6,0	31,3	4G6mmq	4G6mmq + 10x1,5mmq
		230	60	3P+PE	7,9	32,8		
		200/208	50	3P+PE	5,8	30,9	4G10mmq	4G10mmq + 10x1,5mmq
		200/208	60	3P+PE	7,6	32,3		
	Water	400	50	3P+N+PE	6,0	13,3	5G2,5mmq	4G2,5mmq + 10x1,5mmq
		400	60	3P+N+PE	7,5	14,8		
		230	50	3P+PE	5,8	30,8	4G6mmq	4G6mmq + 10x1,5mmq
		230	60	3P+PE	7,6	32,2		
		200/208	50	3P+PE	5,8	30,9	4G10mmq	4G10mmq + 10x1,5mmq
		200/208	60	3P+PE	7,6	32,3		

NOTES: *1 cable dimensioned for a length of 6m;
 *2 cable dimensioned for a length 25m.
 Industrial voltage drop V% 1%; H07 RN-F type cable

2.7. REFRIGERATOR CONNECTION

2.7.1. Installation at equal level

General criteria that must be satisfied in the installation of the remote units:

- 1) Wire gradients (Fig.7)
- 2) Fastening brackets onto the insulated pipes (Fig.8)
- 3) Hermetic sealing (Fig.9).
- 4) Execution of the vacuum (0.03mBar) in the connection pipes (flow and intake). The condensing unit is loaded with freon unless differently indicated.
- 5) Check vacuum sealing of the pipes.
- 6) Opening of the cut-off cocks on the condensing unit.
- 7) Leak control.
- 8) Control of the exact gas load via the liquid passage indicator light positioned on the condensing unit.
- 9) Control of the circulation and pressure of the condensing water (systems with water cooling).



The criteria indicated above are sufficient for installation at equal level (Fig.10)

Length-adjustable piping must be installed, using supports which allow it to slide and provided with sufficient space near walls and other constraints.

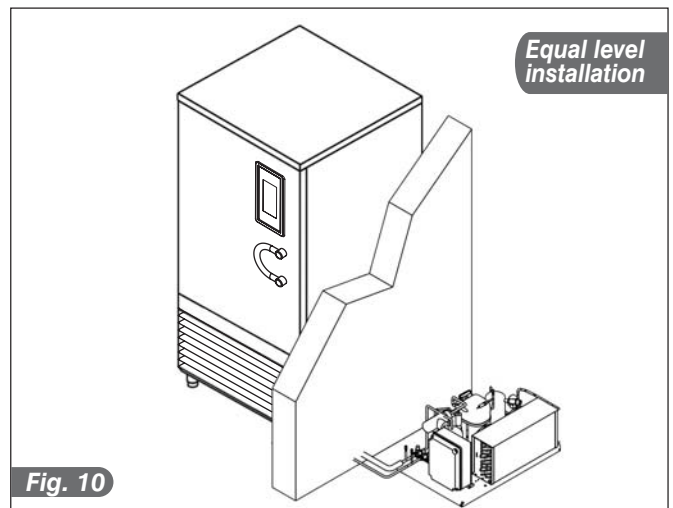
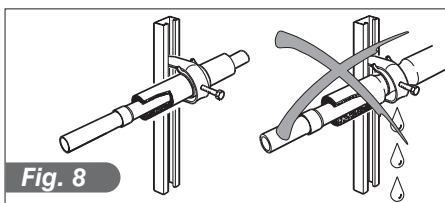
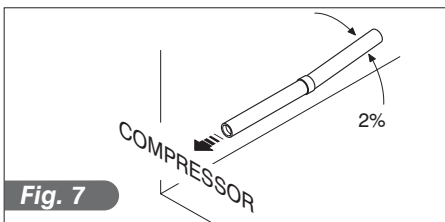

2.7.2. Installation at equal level

If the remote unit is installed higher with respect to the appliance (fig. 12), a siphon must be installed at every start-up or re-ascent (a), every 1.8 metres difference in level along the return pipe and at ever arrival (b).

If the remote unit is installed lower with respect to the appliance, no siphon is necessary (Fig. 11, Fig. 12).

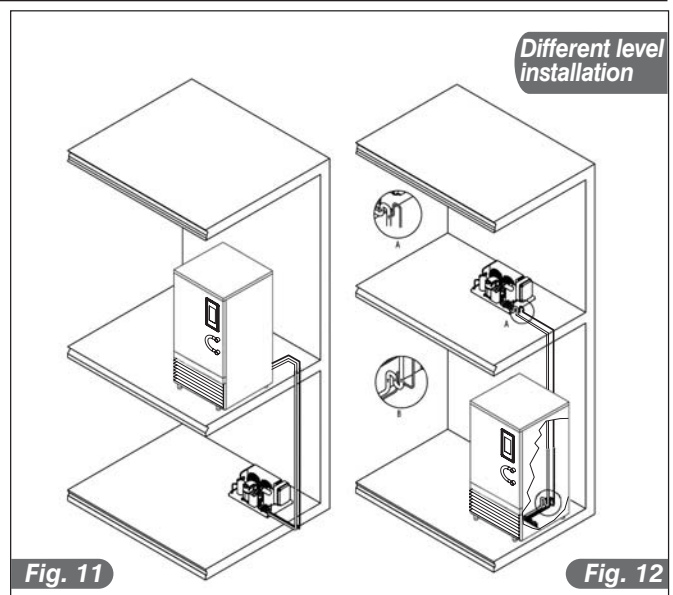

If the heat exchangers of the blast chiller/conservator can be shut off from the rest of the plant by means of valves, these exchangers must be protected by adequate safety devices as foreseen by the standard EN378-2:2008+A1:2009 chapter 6.2.6.8.

For water condensed units or units with heat recovery: when choosing and installing water piping, follow the local provisions and regulations concerning constructions and safety standards. The installer must take care of the mechanical coupling of connections having dimensions appropriate for the system and make sure that the water inlet and outlet connections agree with the dimensional drawing and with the stickers on the connections. The piping must be supported to reduce the weight and tension on the connections. An inspectionable filter which filters solid bodies must be installed on the inlet pipe of the heat exchanger.

If noise and vibrations are critical, anti-vibration fittings must be installed on the inlet and outlet water pipes of the heat exchangers.

2.7.3. Refrigerator-remote units connection

The diameters of the appliance supply pipes are dimensioned or installation distances up to 25 metres (►see **Table 5**).

For greater distances, contact IRINOX SpA.

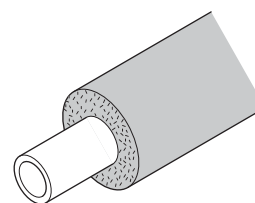

19 mm



The insulation of the intake and hot gas line must be performed using good quality closed cell insulating material, with minimum thickness of 19 mm.

Table 5

MODEL	REMOTE UNIT		WATER UNIT		REMOTE CONDENSER		REMOTE UNIT AND STANDARD REMOTE OR S. SILENCED CONDENSER			
	ø Liquid	ø Intake	ø IN water	ø OUT water	ø IN cond.	ø OUT cond.	ø IN cond.	ø OUT cond.	ø Liquid	ø Intake
	mm	mm			mm	mm	mm	mm	mm	mm
MF25.1	8	10	Fe 3/8"	Fe 3/8"	8	8	/	/	/	/
MF45.1	10	16			12	10	12	10	10	16
MF70.1	12	22			16	12	16	12	12	22
MF30.2	8	10			8	10	/	/	/	/
MF70.2	12	22			16	12	16	12	12	22
MF85.2	12	28			16	12	16	12	12	28

2.7.4 R404A / R452A pressure switches calibration

For the calibration of the R404A / R452A pressure switches,

►see **Table 6**

Table 6

MODEL	AIR COOLED			WATER COOLED	
	HIGH P.	START VENT.	SAFETY VALVE	HIGH P.	SAFETY VALVE
	(Bar)	(Bar)	(Bar)	(Bar)	(Bar)
MF25.1	25	17(*1)	28.5	25	28,5
MF45.1		17			
MF70.1		17			
MF30.2		17(*1)			
MF70.2		17			
MF85.2		17			

*1: Only when the condensing unit or the condenser is remote.

2.8. CONDENSATE DRAIN

The blast chillers have a basin for the collection of condensate. The basin can be extracted from the lower part of the Blast chiller.

2.9. WATER COOLING UNITS CONNECTION

- On inspection (mains water), with the machine at a standstill and water network ready, check that the condenser drain pipe does not allow water to escape. If this is not case, regulate the pressure valve until the leak stops (Fig.13).
- It is recommended to supply a gate valve and an inspectionable filter in the water flow line. The condenser water flow and drain pipes are indicated by relevant plates. Both connections are 3/8" F and threaded.
- See **Table 7** for maximum water consumption

FEATURES OF THE LINE FOR WATER COOLED CONDENSING UNITS	
Maximum pressure of the inlet water	1600 KPa
Minimum pressure of the inlet water	150 KPa
Maximum temperature of the inlet water in order to guarantee normal appliance functioning. Values referring to a water inlet temperature = 15°C	22°C (well water) 35°C (tower water)

Table 7

MAXIMUM WATER CONSUMPTION			
CHAMBER	Power supply frequency (Hz)	WATER	
		l/h	m ³ /h
MF25.1	50	128	0.13
	60	103	0.10
MF45.1	50	345	0.35
	60	435	0.44
MF70.1	50	516	0.52
	60	616	0.62
MF30.2	50	178	0.18
	60	192	0.19
MF70.2	50	516	0.52
	60	616	0.62
MF85.2	50	630	0.63
	60	760	0.76

Values referring to a mains water inlet temperature = 15°C and tower water = 30° C

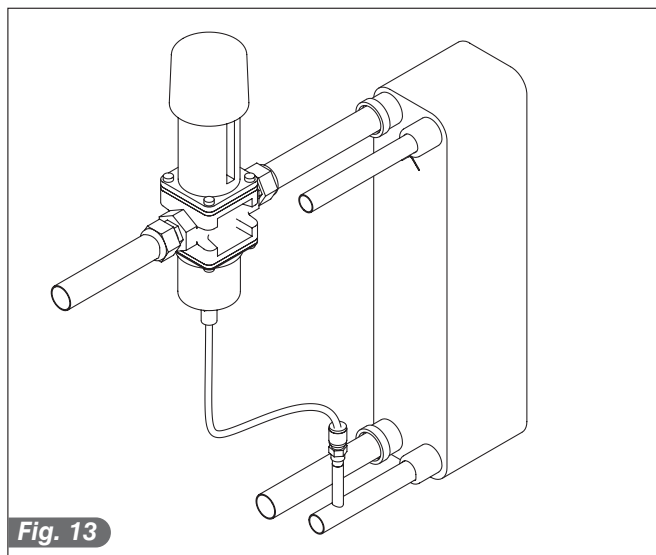

Fig. 13

2.10. NOTES FOR THE INSTALLER

Verification of correct installation and inspection:

- Check for any gas leaks from the seals or joints made during the installation phase.
- Check the good insulation of the connection pipes between preserving unit and remote condensing unit.
- Check the electric connection.
- Check absorption.
- Verify the standard pressures.
- Check the water connection with the regulation of the pressure valve during functioning along with the good circulation of the condensation water.

The safety devices must be installed in such a way that leakage of refrigerant cannot cause any danger. When installing the pressure release piping of the safety valves, the line must comply with local standards.

For loads with more than 100 kg of refrigerant, adequate overflow devices must be installed by the installer as foreseen by the standard EN378-2:2008 + A1:2009 ANNEX F.

 **Inform the customer regarding the exact use of the appliance with specific reference to use and the requirements of the customer himself.**

 **Installation and the start-up must be performed by authorised staff**

2.11. SAFETY AND CONTROL SYSTEMS

- Door micro switch (A): blocks fan functioning in the chamber when the door is opened.
- Protection fuses (B): they protect the circuits from short circuits and overloads.
- Fuse-holders (C): they contain the fuses and they allow the opening and isolating of the circuits.
- Circuit boards (D): on the basis of the parameters acquired, they control the various blast chiller devices connected to it.
- Controls temperature in chamber (E): it is managed by the circuit board via PT1000 probe.
- Safety pressure switch (F): it intervenes in the case of excessive pressure in the refrigerant circuit.
- Safety valve (G): intervenes in the case of excessive pressure in the system and lack of intervention of the safety pressure switch. The intervention discharges the gas in excess in the environment.

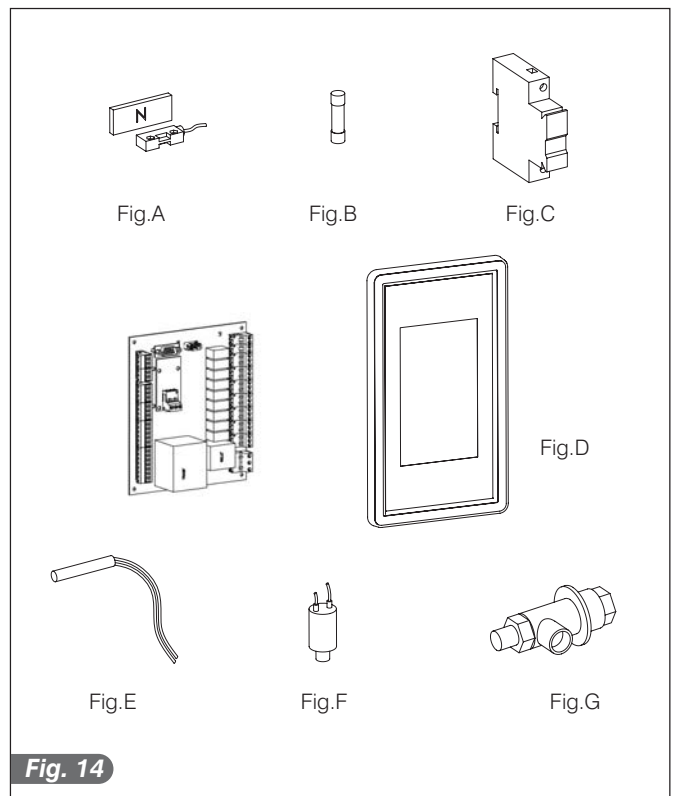

2.12. DISPOSING OF THE MACHINE

The machine must be demolished and disposed of with respect to the Standards in force in the country of installation, especially regarding the compressor refrigerant gas and lubricant oil.

Avoid leakage of refrigerant gas in the environment by using suitable pressurised recipients and instruments to transfer the pressurised fluid. This operation must be entrusted to personnel skilled in refrigeration plants.

INFORMATION FOR THE USERS



On implementation of the 2011/65/CE, 2012/19/UE and 2003/108/CE Directives, relative to the reduction of use of dangerous substances in electric and electronic appliances, as well as disposal of waste.

The barred bin symbol on the appliance or package, indicates that at the end of the product's life, it must be collected separately from other waste.

The selective collection of this appliance at the end of its life is organised and managed by the manufacturer.

The user that wishes to dispose of this equipment must therefore contact the manufacturer and follow the system that the same has adopted to allow the selective collection of the appliance at the end of its life span.

The suitable selective collection for successive start-up of the equipment abandoned for recycling, treatment and compatible environmental disposal contributes to preventing possible negative effects on the environment and favours the re-use and/or recycling of the materials of which the equipment is made.

The abusive disposal of the product by the owner, leads to the application of administrative sanctions envisioned by the Standard.

2.13. R404A / R452A GAS SAFETY SHEET

• Identification of dangers

High exposure to inhalation can have anaesthetic effects. Very high exposure can cause anomalies of the heart beat and cause sudden death. The nebulised or sprayed product can cause cold burns to the eyes or skin. Dangerous for the ozone layer.

• First aid measures

Inhalation

Move the accident victim away from exposure and keep him/her warm and rested. Give oxygen if necessary. Perform artificial respiration if breathing stops or gives signs of stopping. In the case of cardiac arrest, perform external cardiac compression. Request immediate medical assistance.

Contact with the skin

Thaw the affected areas using water. Remove contaminated clothing. Attention: clothing can stick to the skin in the case of cold burns. In the case of contact with the skin, wash immediately with plenty of warm water. If symptoms occur (irritation or the formation of blisters) request medical assistance.

Contact with the eyes

Wash immediately with an eyewash or clean water, keeping the eyelids open for at least 10 minutes. Request immediate medical assistance.

Ingestion

Do not induce vomiting. If the accident victim is conscious, rinse the mouth with water and make him/her drink 200-300 ml of water. Request immediate medical assistance.

Further medical care

Symptomatic treatment and support therapy when indicated. Do not give adrenalin and similar sympathomimetic drugs following exposure, due to the risk of cardiac arrhythmia with possible cardiac arrest.

• Fire-prevention measures

Not inflammable. The heat decomposition causes the emission of very toxic and corrosive vapours (hydrogen chloride, hydrogen fluoride). In the case of fire, use respiratory aids and suitable protective clothing.

Extinguishers

Use extinguishing agents that are appropriate for the fire.

• Use extinguishing agents that are appropriate for the fire.

Inhalation

Higher atmospheric concentrations can cause anaesthetic effects with possible loss of consciousness. Very high exposure can cause anomalies of the heart beat and cause sudden death. Higher concentrations can cause asphyxia due to the reduced content of oxygen in the atmosphere.

Contact with the skin

Sprays of liquid and the nebulised liquid can cause cold burns.

It is improbable that it is dangerous due to cutaneous absorption.

Repeated and prolonged contact can cause the removal of sebaceous matter, with consequent dryness, cracking and dermatitis.

• Ecological information

It decomposes relatively quickly in the lower atmosphere (troposphere). The decomposition products are highly dispersed and therefore have a very low concentration. Does not affect photochemical smog (i.e. it does not lie within the volatile organic compounds -VOC- according to that established by the UN/ECE agreement).

The ozone destruction potential (ODP) is 0 for both R404A and R452A measure in comparison with a standard ODP equal to 1 for the cfc11 (according to uNeP definitions). The Global Warming Potential of the gas is 3260 for R404A and 2141 for R452A.

The substance is governed by the Montreal Protocol (revision dated 1992).

The discharges of the product into the atmosphere do not cause contamination of waters in the long term.

• Considerations regarding disposal

The best solution consists in recovery and recycling of the product.

If this is not possible, destruction must take place in an authorised plant equipped to absorb and neutralise the acid gases and the other toxic products.

• Measures in the case of accidental leaks

Ensure adequate personal protection (with the use of means of protection for the respiratory tract) during the elimination of spills.

If the conditions are sufficiently safe, isolate the source of the leak. In the presence of spills of modest size, leave the material to evaporate on the condition that there is suitable ventilation.

Large leaks

- ventilate the area;
- contain the leaking material with sand, earth or other suitable absorbent material;
- prevent the liquid from penetrating drains, sewers, basements and work holes, because the vapours can create a suffocating atmosphere.

• Handling

Avoid the inhalation of high concentrations of vapours.

The atmospheric concentrations must be reduced to a minimum and kept at the minimum level reasonably possible, below the professional exposure limit.

The vapours are heavier than the air and therefore the formation of high concentrations near to the ground is possible, where ventilation is usually low. In these cases, ensure adequate ventilation or wear suitable protection devices for the respiratory tract with air reserve. Avoid contact with naked flames and hot surfaces as irritant and toxic decomposition products can be formed. Avoid contact between the liquid and the eyes/skin.

3. OPERATION

3.1 USE

The temperature blast chillers have been designed to lower the temperature of foods that have just been cooked in a way to preserve them for a longer period, however keeping the organoleptic features unaltered. The Multi Fresh MF range has been studied to make this operation as easy as possible, offering a wide

customisation of cycles.

These have been studied by IRINOX S.p.A. and its collaborators, divided into 4 specific user categories. In this way, your blast chiller will not only be used to blast chill products but will help you in the production process.

3.2 DESCRIPTION OF THE CYCLES

The MF range has the following cycles:

Cycle	Description
Cycles for CATERING - COOLING	
3°C DELICATE	<p>With this cycle the temperature of the product is quickly reduced to +3°C at the core, with a work temperature that oscillates between 0°C and +2°C.</p> <p>This cycle is particularly indicated for delicate products such as:</p> <ul style="list-style-type: none"> • Mousses, • Spoon desserts,, • Creams, • Desserts, • Vegetables, • Foodstuffs with reduced thickness
3°C STRONG	<p>With this cycle the temperature of the product is quickly reduced to +3°C at the core, with a work temperature that oscillates between -15°C and +2°C.</p> <p>This cycle allows to greatly reduce the work times and is particularly indicated for the following products:</p> <ul style="list-style-type: none"> • High fat content, • Very dense, • Large pieces, • Packaged
Cycles for CATERING - COOLING	
RICE/PASTA 3°C	Cycle dedicated to cooling rice and pasta
VEGETABLES/MUSHROOMS 3°C	Cycle dedicated to cooling vegetables and mushrooms
LASAGNA 3°C	Cycle dedicated to cooling lasagna
FISH 3°C	Cycle dedicated to cooling fish
MEAT 3°C	Cycle dedicated to cooling pre-cut meat
SOUPS/SAUCES 3°C	Cycle dedicated to cooling soups and sauces
SAVOURY TARTS 3°C	Cycle dedicated to cooling savoury tarts
CONFECTIONERY 3°C	Cycle dedicated to cooling confectionery products
BREAD 3°C	Cycle dedicated to cooling bread
Cycles for CATERING - COOLING	
-18°C DELICATE	<p>This cycle envisions two freezing phases.</p> <p>In the first phase, the core temperature of the product is taken to +6°C, with a work temperature of 0°C.</p> <p>In the second phase, the core temperature of the product is taken to -18°C, with a work temperature that can reach -40°C.</p> <p>This cycle is indicated for freezing all cooked foods, in particular raised and oven-cooked products</p>

Cycle	Description
Cycles for CATERING - FREEZING	
-18°C STRONG	With this cycle the temperature of the product is quickly reduced to -18°C at the core, with a work temperature that can reach -40°C. This cycle is particularly indicated for all raw foods and for cooked foodstuffs with a particular thickness
VEGETABLES/MUSHROOMS -18°C	Cycle dedicated to freezing vegetables and mushrooms
RICE/PASTA -18°C	Cycle dedicated to freezing rice and pasta
LASAGNA -18°C	Cycle dedicated to freezing lasagna
FISH -18°C	Cycle dedicated to freezing fish
MEAT -18°C	Cycle dedicated to freezing meat
SOUPS/SAUCES -18°C	Cycle dedicated to freezing soups and sauces
SAVOURY TARTS -18°C	Cycle dedicated to freezing savoury tarts
CONFECTIONERY -18°C	Cycle dedicated to freezing confectionery products
BREAD -15°C	Cycle dedicated to freezing bread
Cycles for CATERING - COOKING AT LOW HEAT	
CHICKEN	Cycle dedicated to cooking chicken at low heat. You can select the form of preservation at the end of the cooking cycle (blast chilling, freezing, keeping warm).
BEEF	Cycle dedicated to cooking beef at low heat. You can select the form of preservation at the end of the cooking cycle (blast chilling, freezing, keeping warm).
PORK	Cycle dedicated to cooking pork at low heat. You can select the form of preservation at the end of the cooking cycle (blast chilling, freezing, keeping warm).
FISH	Cycle dedicated to cooking fish at low heat. You can select the form of preservation at the end of the cooking cycle (blast chilling, freezing, heat maintenance).
Cycles for CATERING - REGENERATION	
MEAT	Cycle dedicated to regeneration of meat
FISH	Cycle dedicated to regeneration of fish
VEGETABLES	Cycle dedicated to regeneration of vegetables
BREAD	Cycle dedicated to regeneration of bread
SINGLE PORTION	Cycle dedicated to regeneration of single portions
CONFECTIONERY	Cycle dedicated to regeneration of confectionery
Cycles for CATERING - RISING	
LONG	Cycle dedicated to long rising
DIRECT	Cycle dedicated to short rising
NIGHT	Cycle dedicated to rising at night
Cycles for CATERING - DEFROSTING	
CHICKEN	Cycle dedicated to defrosting chicken
BEEF	Cycle dedicated to defrosting beef
PORK	Cycle dedicated to defrosting pork
FISH	Cycle dedicated to defrosting fish







Cycle	Description
Cycles for CATERING - MAINTENANCE	
MEAT	Cycle dedicated to maintenance of meat
FISH	Cycle dedicated to maintenance of fish
VEGETABLES	Cycle dedicated to maintenance of vegetables
BREAD	Cycle dedicated to maintenance of bread
SINGLE PORTION	Cycle dedicated to maintenance of single portions
CONFECTIONERY	Cycle dedicated to maintenance of confectionery
Cycles for CATERING - PASTEURISATION	
MEAT	Cycle dedicated to pasteurisation of meat
FISH	Cycle dedicated to pasteurisation of fish
VEGETABLES	Cycle dedicated to pasteurisation of vegetables
CREAMS	Cycle dedicated to pasteurisation of creams
Cycles for CONFECTIONERY - COOLING	
3°C DELICATE	See the same cycle for CATERING
3°C STRONG	See the same cycle for CATERING
MIXES IN MOULDS 10°C	Cycle dedicated to cooling mixes poured into moulds
MIXES IN LAYERS 10°C	Cycle dedicated to cooling mixes in layers, such as: <ul style="list-style-type: none"> • Sponge cakes • Biscuits
CREAMS 25°C	Cycle dedicated to cooling hot creams to be taken to a core temperature of 25°C
CREAMS 3°C	Cycle dedicated to cooling hot creams to be taken to a core temperature of 3°C
LEAVENED GOODS 20°C	Cycle dedicated to cooling leavened goods to be taken to a core temperature of 20°C
LEAVENED GOODS 3°C	Cycle dedicated to cooling leavened goods to be taken to a core temperature of 3°C
LEAVENED GOODS -7°C	Cycle dedicated to cooling leavened goods to be taken to a core temperature of -7°C
MIXES 12°C	Cycle dedicated to cooling mixes
PUFF PASTRY 12°C	Cycle dedicated to cooling puff pastry
Cycles for CONFECTIONERY - FREEZING	
-18°C DELICATE	See the same cycle for CATERING
-18°C STRONG	See the same cycle for CATERING
MIXES IN MOULDS	Cycle dedicated to freezing mixes poured into moulds
TARTS -18°C	Cycle dedicated to freezing tarts to be taken to a core temperature of -18°C
MIXES IN LAYERS -18°C	Cycle dedicated to freezing mixes in layers
LEAVENED GOODS -18°C	Cycle dedicated to freezing leavened goods to be taken to a core temperature of -18°C
MOUSSES -18°C	Cycle dedicated to freezing mousses
COMPLETE MOUSSES	Cycle dedicated to freezing complete mousses
MACAROONS -18°C	Cycle dedicated to freezing macaroons
PRE-LEAVENED GOODS -18°C	Cycle dedicated to freezing pre-leavened goods



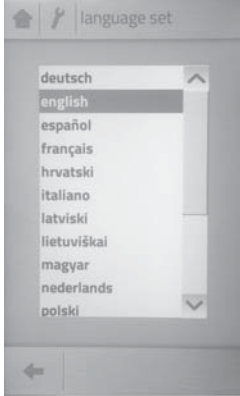

Cycle	Description
Cycles for CONFECTIONERY - FREEZING	
ICE CREAM -18°C	Cycle dedicated to freezing ice cream to be taken to a core temperature of -18°C
ICE CREAM -12°C	Cycle dedicated to freezing ice cream to be taken to a core temperature of -12°C
Cycles for CONFECTIONERY - COOKING AT LOW HEAT	
MERINGUES	Cycle dedicated to cooking meringues at low heat.
CREME BRULEE 3°C	Cycle dedicated to cooking creme brulee at low heat.
CREME BRULEE -18°C	Cycle dedicated to cooking creme brulee at low heat.
FRUIT POCHET 3 °C	Cycle dedicated to cooking fruit pochet at low heat.
FRUIT POCHET -18 °C	Cycle dedicated to cooking fruit pochet at low heat.
DACQUOISE	Cycle dedicated to cooking dacquoise at low heat.
Cycles for CONFECTIONERY - RISING	
LONG	Cycle dedicated to long rising
DIRECT	Cycle dedicated to short rising
NIGHT	Cycle dedicated to rising at night
Cycles for CONFECTIONERY - PASTEURISATION	
ICE CREAM BASES	Cycle dedicated to pasteurisation of ice cream bases
CREAMS	Cycle dedicated to pasteurisation of creams
Cycles for CONFECTIONERY - CHOCOLATE	
CHOCOLATE 45°C	Cycle dedicated to chocolate
CHOCOLATE -7°C	Cycle dedicated to chocolate to be taken to a core temperature of -7°C
CHOCOLATE -18°C	Cycle dedicated to chocolate to be taken to a core temperature of -18°C
COOLING OF MOULDS	Cycle dedicated to cooling moulds
Cycles for CONFECTIONERY - FRESHENING	
MIGNONS	Cycle dedicated to freshening mignons
LEAVENED GOODS	Cycle dedicated to freshening leavened goods
MIXES	Cycle dedicated to freshening mixes
ICE CREAM -15°C	Cycle dedicated to freshening ice cream
Cycles for BAKERY PRODUCTS - COOLING	
3°C DELICATE	See the same cycle for CATERING
3°C STRONG	See the same cycle for CATERING
SAVOURY TARTS 3°C	Cycle dedicated to cooling savoury tarts
CREAMS 3°C	Cycle dedicated to cooling creams
LEAVENED GOODS 3°C	Cycle dedicated to cooling leavened goods
PRE-BAKED BREAD	Cycle dedicated to cooling pre-baked bread
MIXES 10°C	Cycle dedicated to cooling mixes
TARTS 3°C	Cycle dedicated to cooling tarts

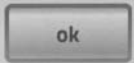
Cycle	Description
Cycles for BAKERY PRODUCTS - FREEZING	
-18°C DELICATE	See the same cycle for CATERING
-18°C STRONG	See the same cycle for CATERING
TARTS -18°C	Cycle dedicated to freezing tarts
UNCOOKED TARTS -18°C	Cycle dedicated to freezing uncooked tarts
PRE-BAKED BREAD	Cycle dedicated to freezing pre-baked bread
Cycles for BAKERY PRODUCTS - FRESHENING	
LONG	Cycle dedicated to long rising
DIRECT	Cycle dedicated to short rising
NIGHT	Cycle dedicated to rising at night
Cycles for BAKERY PRODUCTS - FRESHENING	
BAKED BREAD	Cycle dedicated to freshening baked bread
PRE-BAKED BREAD	Cycle dedicated to freshening pre-baked bread
Cycles for ICE CREAM INDUSTRIES - COOLING	
3°C DELICATE	See the same cycle for CATERING
3°C STRONG	See the same cycle for CATERING
CREAMS 3°C	Cycle dedicated to cooling creams
LEAVENED GOODS 3°C	Cycle dedicated to cooling leavened goods
Cycles for ICE CREAM INDUSTRIES - FREEZING	
-18°C DELICATE	See the same cycle for CATERING
-18°C STRONG	See the same cycle for CATERING
MOUSSES -18°C	Cycle dedicated to freezing mousses
COMPLETE MOUSSES	Cycle dedicated to freezing complete mousses
ICE CREAM -18°C	Cycle dedicated to freezing ice cream to be taken to a core temperature of -18°C
ICE CREAM -12°C	Cycle dedicated to freezing ice cream to be taken to a core temperature of -12°C
Cycles for ICE CREAM INDUSTRIES - COOKING AT LOW HEAT	
MERINGUES	Cycle dedicated to cooking meringues at low heat.
FRUIT POCHET 3 °C	Cycle dedicated to cooking fruit pochet at low heat.
FRUIT POCHET -18 °C	Cycle dedicated to cooking fruit pochet at low heat.
Cycles for ICE CREAM INDUSTRIES - RISING	
LONG	Cycle dedicated to long rising
DIRECT	Cycle dedicated to short rising
NIGHT	Cycle dedicated to rising at night
Cycles for ICE CREAM INDUSTRIES - PASTEURISATION	
ICE CREAM BASES	Cycle dedicated to pasteurisation of ice cream bases
CREAMS	Cycle dedicated to pasteurisation of creams
Cycles for ICE CREAM INDUSTRIES - CHOCOLATE	
CHOCOLATE 45°C	Cycle dedicated to chocolate
CHOCOLATE -7°C	Cycle dedicated to chocolate to be taken to a core temperature of -7°C
CHOCOLATE -18°C	Cycle dedicated to chocolate to be taken to a core temperature of -18°C
COOLING OF MOULDS	Cycle dedicated to cooling moulds
Cycles for ICE CREAM INDUSTRIES - FRESHENING	
ICE CREAM -15°C	Cycle dedicated to freshening ice cream
Cycles for ICE CREAM INDUSTRIES - MAINTENANCE	
ICE CREAM -15°C	Cycle dedicated to maintenance of ice cream

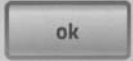

3.3 DESCRIPTION AND OPERATION

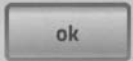

3.3.1 Preliminary operations



Phase	Description	Front panel screen
3.3.1.1 INITIAL START-UP		
1	The LANGUAGE, CURRENT DATE AND TIME and SECTOR configuration windows appear when you start up the machine for the first time.	
2	In the LANGUAGE SELECTION window, press the key for the required language.	
3	In the DATE AND TIME SELECTION window, enter the date by pressing the key 	
4	A window opens showing a calendar for selecting the date.	
5	In the DATE AND TIME SELECTION window, set the date and time and confirm by pressing 	







Phase	Description	Front panel screen
6	Select the unit of measurement for the temperature and confirm by pressing 	
7	In the SECTOR SELECTION window, select the icon indicating your main sector of use and confirm by pressing 	
3.3.1.2 HEATING		
	This step is automatically carried out when the machine is off for a period longer than 12 hrs. Heating time has a duration of 1 hrs with the goal of improving the compressor life.	



3.3.2 Selecting the cycles



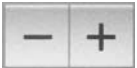



Phase	Description	Front panel screen
1	In the main window, the first group of cycles is shown filtered according to sector. 1. COOLING 2. DEFROSTING 3. REGENERATION 4. RISING 5. FREEZING 6. MAINTENANCE 7. COOKING AT LOW HEAT 8. PASTEURISATION	
2	Select the required function by pressing the relative button (1-8).	
3	The list of cycles in the various groups appears.	



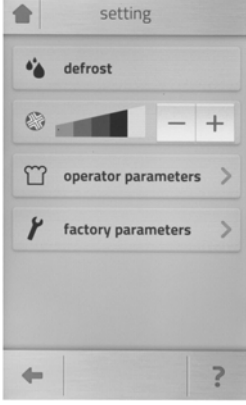

Phase	Description	Front panel screen
4	Press the required cycle, then press 	
5	To end the cycle, press 	
6	When the cycle ends, this appears	





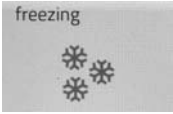



Phase	Description	Front panel screen
3.3.2.1 AUTOMATIC MODE		
1	Insert the core probe into the product and press 	
2	AUTOMATIC mode is selected The display shows: 1. Current type of cycle 2. Progress of cycle as a percentage 3. Current phase 4. Air temperature 5. Core probe temperature 6. Ventilation control	
3	To end the cycle, press 	

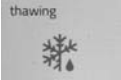





Phase	Description	Front panel screen
3.3.2.2 MANUAL MODE		
1	Do not insert the core probe into the product and press 	
2	MANUAL mode is selected. The display shows: 1. Type of cycle 2. Progress of cycle as a percentage 3. Current phase 4. Air temperature 5. Duration of phase 6. Ventilation control	
3	Pressing  allows you to change the duration of the current phase at will.	
4	Ventilation speed can be modified for each phase in progress by pressing 	
5	When the cycle ends, this appears	



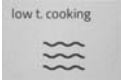

Phase	Description	Front panel screen
3.3.2.3 FAVOURITES		
1	To view your favourites library, press  in the menu shown in the picture	
2	You can now select the required cycle	



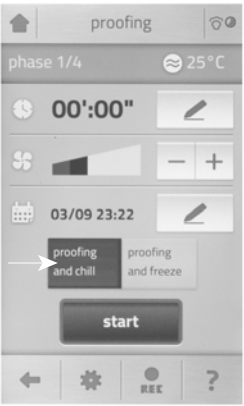

Phase	Description	Front panel screen
3.3.2.4 DEFROST		
1	Press the key 	
2	To access the demisting cycle, press 	
3	Open the door Press  to start the cycle	
4	Press the key  to modify the cycle time	

Phase	Description	Front panel screen
3.3.2.5 COOLING AND FREEZING		
1	<p>In the main window, press the button to open the cycle start window</p> 	
2	<p>If the automatic core probe detection function is disabled, select the required work mode</p>	
3	<p>When the temperature at the core reaches the temperature set for indication, the warning message appears</p>	





Phase	Description	Front panel screen
3.3.2.6 THAWING		
1	In the main window, select the button 	
2	Select the product	
3	Press key (1) to modify the thickness of the product. <ul style="list-style-type: none"> • 1st or 2nd notch for products 4 cm MAX • 3rd notch for products between 4 and 7 cm • 4th notch for products between 7 and 10 cm • 5th notch for products 10 cm MAX 	
4	Press the button  to start the cycle	
5	When the cycle ends, the indication appears	
6	To end the cycle, press 	





Phase	Description	Front panel screen
3.3.2.7 COOKING AT LOW HEAT		
1	In the main window, select the button 	
2	Select the product	
3	Before starting the cycle, you can select how it ends: <ul style="list-style-type: none"> • +3°C: once cooked, the product is cooled • +65°C: once cooked, the product is kept warm • -18°C: once cooked, the product is frozen 	
4	Press the button  to start the cycle	
5	You can set a product MATURATION phase by pressing  The maturation phase maintains a specific temperature for a certain length of time and begins after the cooking phases.	
6	To end the cycle, press 	

Phase	Description	Front panel screen
3.3.2.8 PROOFING		
1	THE PROOFING CYCLES ARE MANUAL ONLY (WITH TIMER)	
2	In the main window, select 	
3	Select the type of proofing	
4	Pressing the key  allows you to set a cycle end date, in which case proofing is postponed and the product is kept frozen for the required length of time. Before starting the cycle, you can select how to end it: <ul style="list-style-type: none"> • PROOFING and CHILL: after it has proofing, the product is cooled • PROOFING and FREEZE: the product is frozen 	
5	Press the button  to start the cycle	



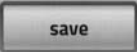

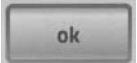
Phase	Description	Front panel screen
3.3.2.9 PASTEURISATION		
1	In the main window, select 	
2	Select the type of product	
3	Before starting the cycle, you can select how it ends: <ul style="list-style-type: none"> • Pasteurise: after pasteurisation, the product is kept warm • Pasteurise and cool: after pasteurisation, the product is cooled • Pasteurise and freeze: after pasteurisation, the product is frozen 	
4	Press the button  to start the cycle	





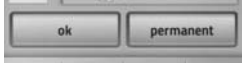
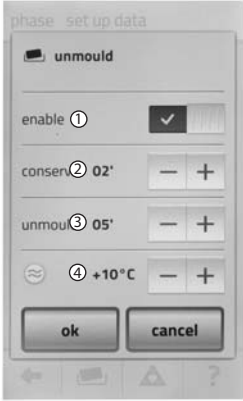
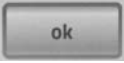
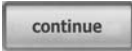

3.3.3 Functions





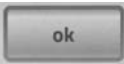

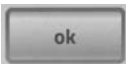
Phase	Description	Front panel screen
3.3.3.1 CONTINUOUS CYCLE <i>Function enabled only for delicate cycles at +3°C and strong cycles at -18°C in manual mode</i>		
1	<p>With the continuous cycle function enabled, the cycle continues indefinitely.</p> <ol style="list-style-type: none"> 1. Type of cycle 2. Progress of cycle 3. Phase 4. Air temperature 5. Ventilation control 6. Enabling the CONTINUOUS CYCLE 7. Positioning and type of foodstuff 	
2	<p>After selecting the continuous cycle function, you can select the type of product by pressing</p> 	
3	<p>Select the position of the tray in the blast chiller</p>	
4	<p>Select the product in use</p>	
5	<p>If the product is not shown in the list, you can add it with</p> 	



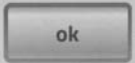

Phase	Description	Front panel screen
6	Enter the name of the product to be added and press 	
7	After selecting the foodstuff, set the timer	
8	When the timer ends, this appears END OF CYCLE by pressing  the cycle continues as normal	
9	In the main window, the first foodstuff about to end and the remaining time and position of the tray are shown.	

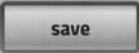

This function can be enabled only for the cooling and freezing cycles.

Phase	Description	Front panel screen
3.3.3.2 TURNING OUT		
1	Select a cycle and press 	
2	To enable the TURNING OUT function, press 	
3	These must be set: 1. enable turning out 2. turning out start time 3. turning out duration 4. temperature set-point in chamber during turning out	
4	Turning out begins at the end of phase 1 of the cycle and the warning message appears. Press  to start the turning out process. When the timer for turning out ends, the program starts phase 2; alternatively, you can press  to stop turning out immediately.	

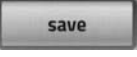
Phase	Description	Front panel screen
3.3.3.3 CORE PROBE TEMPERATURE INDICATION		
1	Select a cycle and press 	
2	To set the function, press 	
3	Set the temperature for indication press  to confirm	
4	When the temperature at the core reaches the temperature set for indication, the warning message appears Press  to confirm the indication	

Phase	Description	Front panel screen
3.3.3.4 ENTERING CYCLES IN THE FAVOURITES AREA		
1	Access the required group of cycles	
2	To save a cycle in the favourites library, press 	
3	Select the cycle to be added to the list of favourites	
4	Confirm by pressing 	
5	You can modify the name of the cycle. By pressing  you accept the default name or the new one you have entered.	
6	You are then taken back to the cycle selection window	

Phase	Description	Front panel screen
3.3.3.5 RECORDING CYCLES		
<p>1</p> <p>2</p> <p>3</p>	<p>You can save an automatic cycle by pressing</p>  <p>For the cycle to be recorded:</p> <ol style="list-style-type: none"> 1. The cycle must be AUTOMATIC 2. There must not be any alarms in progress. <p>Otherwise, the cycle cannot be recorded.</p> <p>When the cycle ends, press</p> 	
<p>4</p>	<p>Enter the name of the cycle that has just been saved, and press</p> 	
<p>5</p>	<p>To use it again, simply select it in the favourites menu</p>	

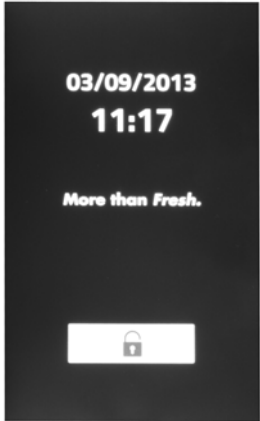
Phase	Description	Front panel screen
3.3.3.6 DISABLING THE KEYBOARD		
1	<p>To turn off the screen, press the "off" button</p> 	
2	<p>You can then carry out operations such as cleaning the display.</p> <p>To re-enable the keyboard, press the key</p> 	

3.4 STOPPING MODES

To stop the machine in an emergency, press the key



and turn off the power at the control board (Fig. 17).

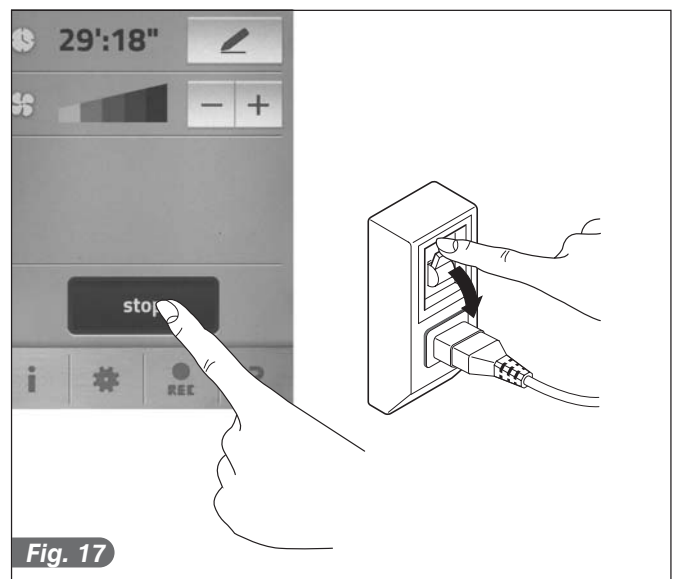

Fig. 17

3.5 RECOMMENDATIONS FOR USE

Before starting the machine, clean the inside of the chamber thoroughly (► see par. 4.2).

3.5.1 Loading the products

Do not cover the trays and containers with insulating film lid: the greater the surface of the foodstuff exposed to the contact with cold air, the shorter the blast chilling times.

It is recommended to use trays and containers that are as least deep as possible and however not more than 6.5 cm.

For best results, we recommend the use of containers with 3.5 kg of product and with a maximum thickness of 8 cm for quick blast chilling or 5 cm for quick freezing. For difficult and/or fatty products, reduce the thickness further.

Make sure that a sufficient space is left between the trays in a way to allow suitable air circulation.

If the machine is not loaded completely, concentrate the trays in the centre part of the blast chiller placing an empty tray (A) above the last tray.

Position the trays in the most internal part of the tray-holders, making sure that they are as near as possible to the evaporator.

Do not overload the machine beyond that established by the manufacturer ("Trays capacity and Yield" Tab.).

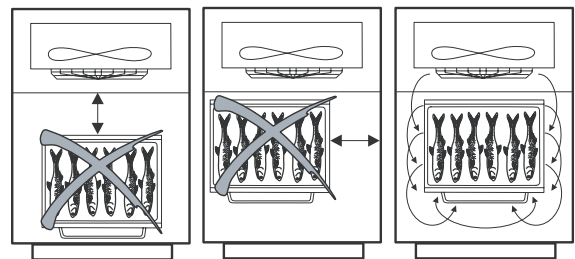
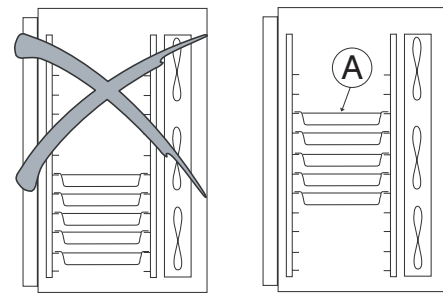
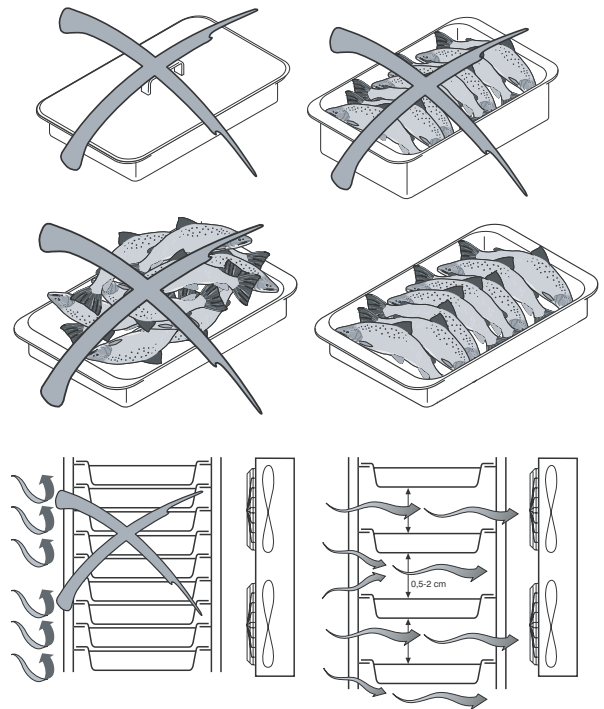

MODELS	Yields	
	Blast chilling (Kg)	Freezing (Kg)
MF25.1	25	25
MF45.1	45	45
MF70.1	70	70
MF30.2	30	30
MF70.2	70	70
MF85.2	85	85

The yields are declared in the following conditions:
 - Trays filled with water at 90°C
 - Environment temperature: 32°C
 - No chamber pre-cooling

MODELS	CATERING						CONFECTIONERY		
	GN 1/1 h=20	GN 1/1 h=40	GN 1/1 h=65	GN 2/1 h=20	GN 2/1 h=40	GN 2/1 h=65	400x600 h=20	400x600 h=40	400x600 h=60
MF25.1	8	5	4				8	5	4
MF45.1	18	12	9				18	12	9
MF70.1	27	18	13				27	18	13
MF30.2	16	10	8	8	5	4	8*	5*	4*
MF70.2	36	24	18	18	12	9	18*	12*	9*
MF85.2	54	36	26	27	18	13	27*	18*	13*

(*) tray to rested on 530x650mm grill

3.5.2. Pre-cooling

Before a quick blast chilling cycle and/or quick freezing, it is indispensable to pre-cool the chamber in a way to reduce work times even further. Before inserting the product to be blast chilled, perform a pre-cooling cycle, a DELICATE cycle or STRONG vacuum.

 To prevent damage to the machine, do not leave hot products inside the chamber. As soon as the product to be treated has been inserted, start the cycle immediately.

3.5.3. Core probe

The core probe must be positioned correctly at the centre of the largest piece of product, making sure that the point of the probe does not escape from the product itself and does not touch the tray. In order to prevent undesired contamination, the probe must be clean and sanitised before every work cycle.

For best results, we recommend the use of GN1/1 containers with 3.5 kg of product and with a maximum thickness of 8 cm for quick blast chilling or 5 cm for quick freezing.

For difficult and/or fatty products, reduce the thickness further.

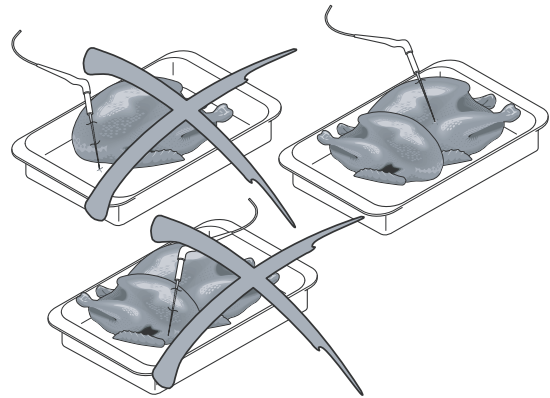

3.5.4. Temperatures

Do not leave the cooked foodstuffs to be blast chilled and/or frozen for a long time at room temperature.

The greater the moisture lost, the less the softness conserved inside the foodstuff.

It is recommended to start the blast chilling and/or quick freezing cycle as soon as the preparation and/or cooking has been completed, taking care to introduce the foodstuff into the blast chiller at a temperature that is not below +70°C. Cooked food can enter the blast chiller also at very high temperatures (> 100°C), as long as the chamber is pre-cooled. Remember that the cycle reference times start from +90°C (from +90°C to +3°C in the quick blast chilling cycle; from +90°C to -18°C in the quick freezing cycle).

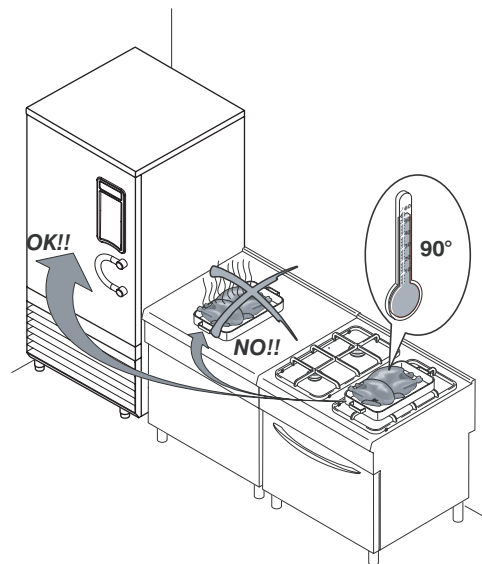

3.5.5 Conservation

The blast chilled and/or frozen food must be covered and protected (with film, hermetic lid or, even better, vacuum packed) and marked using a sticker stating the content, the day of preparation and the expiry date, in indelible ink.

 The blast chilled food must be conserved in a refrigerated cabinet at a constant temperature of +2°C.

 The frozen food must be conserved in a freezing cabinet at a constant temperature of -20°C.



 Do not use the blast chiller like a normal refrigerator!

CONTENT _____









Preparation date _____

Expiry date _____

3.6 Programming the parameters

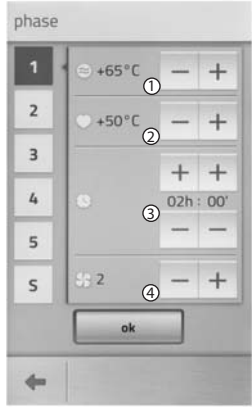
Phase	Description	Front panel screen
3.6.1 CONFIGURING THE OPERATOR PARAMETERS		
1	In the main window, press  to access the settings menu.	
2	Press "Operator parameters"	
3	Press the keys to scroll through the list of parameters	

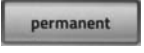
OPERATOR PARAMETERS		
Item	Default Values	Description
COMPANY NAME		Name of the Customer's Company
SET DATE/TIME	xx/xx/xxxx 0:00	Configuration of the date/time of the blast chiller
LANGUAGE		Setting the language in the menus
UNIT OF MEASUREMENT	°C	Unit of measurement of the temperatures
MACHINE I.D.	01	Unmistakable number of the blast chiller. (Necessary for the connection of the blast chiller via BUS network)
PERIPHERAL ADDRESS		Serial connection address
SET PASSWORD		Password configuration
PERIOD OF RECORDINGS	00'	Interval of time, expressed in minutes, of the recordings. n=0: none recordings n 0: active Registrations
TYPE OF RECORDINGS	BLAST CHILL	BLAST CHILL only during the cycle recording BLAST CHILL+PRESERVATION CYCLE cycle and preservation recording

Phase	Description	Front panel screen
3.6.2 MODIFYING THE CYCLE PARAMETERS		
1	The parameters of a cycle can be modified either temporarily or permanently.	
2	<p>The parameters can be modified with the cycle in progress or in standby.</p> <p>Press</p>  <p>to view the phases of the cycle.</p>	
3	<p>The cycle can comprise various phases depending on the process to be carried out. "S" = PRESERVATION</p> <p>The preset parameters of each phase of the cycle are displayed.</p> <p>To modify the parameters, select the required phase</p>	
4	<p>Select a phase to modify the following parameters:</p> <ol style="list-style-type: none"> 1. Air temperature 2. Core temperature 3. Phase time 4. Evaporator fan speed <p>To remove a phase: set the time of the phase = 0</p> <p>After modifying a value, confirm it</p> 	
5	<p>To save only the changes made to the cycle in progress, press</p>  <p>To permanently save the changes, press</p>  <p>To cancel and return to the cycle, press</p> 	

3.7 SANIGEN

What is it:

Sanigen is a sanitising system that releases **active ions** to reduce the bacteria content present in the air treated and in the surfaces with which it comes into contact. As the air is the carrier of the sanitising process, there are no inaccessible areas, i.e. complete sanitising is guaranteed everywhere. Sanitisation takes place on the surface of the food products and mainly in the environment, which carries 97% of bacterial contamination for foods.

The absence of bacteria content allows to obtain the following advantages inside the chamber:

- continuous sanitising inside the chamber through time,
- all of the surfaces are treated
- no bad smells,

When to use it:

Sanigen can always be used except during leavening.

How to use it:





Sanigen is installed directly in the factory when requested. The functioning parameters are set in the Factory Parameters and are the fruit of Irinox experience and laboratory tests. Its functioning is completely automatic.

How does the sanitising cycle function:





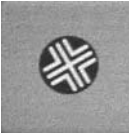

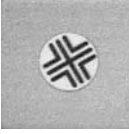
sanitising is always active except during the proofing cycle (if envisioned)

- When the temperature in the chamber $\geq 0^{\circ}\text{C}$ (parameter set in the factory)
 - ~ The sanitising system is activated for a set time
 - The fans in the chamber are controlled for a set time
 - When the fans functioning time has expired, these remain off for a set time
 - ~ When the functioning time has expired, the sanitising system is switched off for the set time
 - The fans functioning and pause times in the chamber are reset.
- When the temperature in the chamber $< 0^{\circ}\text{C}$ (parameter set in the factory)
 - ~ the sanitising cycle is not carried out









Phase	Description	Front panel screen
SANIGEN - How to see if sanitising is active:		
1	<p>In the main window press</p>  <p>to access the settings menu.</p>	
2	<p>To increase or decrease the aggressiveness of treatment, press the buttons</p> 	
3	ACTIVATED (GREEN)	
4	DEACTIVATED	
5	ENABLED BUT NOT ACTIVATED	

Routine maintenance:

EVERY 6 MONTHS: Cleaning		
0	Remove the power supply to the preserving unit and access the Sanigen	
1	Release the external tab, holding the glass cylinder still	
2	Remove the external net from the glass cylinder, paying attention not to break the glass	
3	Tighten the glass cylinder anti-clockwise, always acting on the red plastic base Wash the external net in warm water, paying attention not to deform it. Remove any dust deposits carefully	
4	Wash the external net in warm water, paying attention not to deform it. Remove any dust deposits carefully	
5	Clean the glass cylinder with a damp cloth. Remove any dust deposits carefully	
6	Tighten the glass cylinder clockwise, always acting on the red plastic base	
7	Check that the glass cylinder is not cracked. If this is the case, the glass cylinder must be replaced	
8	Insert the external net, paying attention not to overlap the internal net and keep a distance of about 5 mm from the red base	
9	Keeping the glass cylinder still, re-insert the external tab checking that it is in good contact with the external net	

YEARLY: replacement of the glass cylinder and external net

Order the glass cylinder and external net from IRINOX CODE 3880410		
0	Remove the power supply to the preserving unit and access the Sanigen	
1	Release the external tab, holding the glass cylinder still	
2	Tighten the glass cylinder anti-clockwise, always acting on the red plastic base	
3	Dispose of the glass cylinder with the external net as dry waste, as it is made from re-cyclable materials	
4	Check that the new glass cylinder is not cracked. If this is the case, the glass cylinder must be replaced	
5	Tighten the new glass cylinder clockwise with the external net, always acting on the red plastic base	
6	Check that the external net does not overlap the internal net and keep a distance of about 5 mm from the red base	
7	Keeping the glass cylinder still, re-insert the external tab checking that it is in good contact with the external net	

4. MAINTENANCE

4.1. ROUTINE MAINTENANCE

The information and the instructions in this chapter are destined to all staff operating the machine: the user, the maintenance technician, as well as unskilled staff.

Elementary Safety Standards

In order to clean and carry out routine maintenance in safety, refer to the Safety Standards in par. 1.5 (►► Fig.16):

- do not touch or operate the machine with damp or wet feet and hands.
- do not insert screwdrivers, kitchen tools or other between the protections and moving parts before cleaning and routine maintenance operations.
- disconnect the blast chiller from the electric power supply mains by turning the master switch off and disconnecting the plug.
- do not pull the power supply cable to disconnect the machine from the power supply mains Fig. 16



It is prohibited to remove the protections and safety devices in order to perform routine maintenance. The manufacturer declines any liability for accidents caused by failure to comply with the afore-mentioned obligation.



Before starting the machine, clean the inside of the chamber thoroughly as indicated in paragraph 4.2.

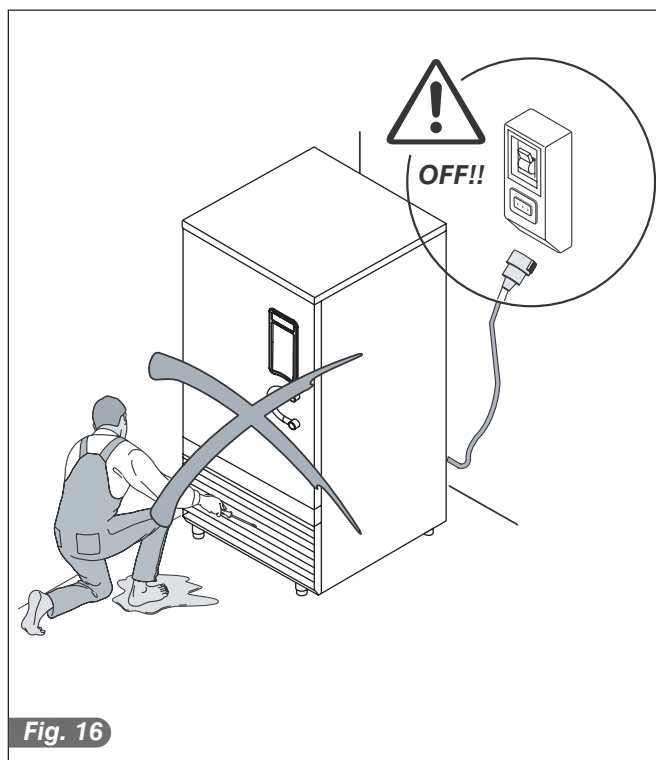

Fig. 16

4.2. CLEANING THE CHAMBER

In order to guarantee hygiene and protection of the quality of the foodstuffs treated, the internal cleaning of the chamber must be performed at the end of every working day. Weekly cleaning is recommended.

The conformation of the cell and the internal components allow to wash using a cloth or sponge.

Clean using water and non-abrasive neutral detergents. rinsing is performed with a cloth or sponge soaked in water or with a moderate jet of water (not exceeding mains pressure).



Do not scrape the surfaces with sharp or abrasive bodies.



Do not use abrasives or solvents and thinners.



Always wear protective gloves during the following operations.



Do not use cleaning agents containing acetic acid and derivatives or ammonia;



Do not use the blast chiller in direct contact with products emanating acetic acid and derivatives or ammonia

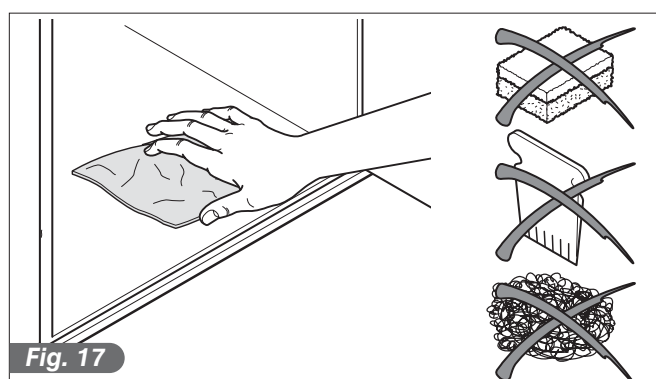

Fig. 17

4.2.1. Washing the evaporator



Always wear following gloves during the following operations.

HOW TO ACCESS THE EVAPORATOR:

It is possible to access internal evaporator cleaning by using a flat screwdriver to loosen the screws situated on the right side of the fan-holder panel and turning the latter to the left.

METHODS FOR CLEANING THE EVAPORATOR

To clean the evaporator, use a brush with vertical movements along the direction of the aluminium fins.

On completion, close the fan-holder panel by performing the operations in reverse order.



Do not use high pressure water jets



Do not use water jets



Do not damage the refrigerant circuit.

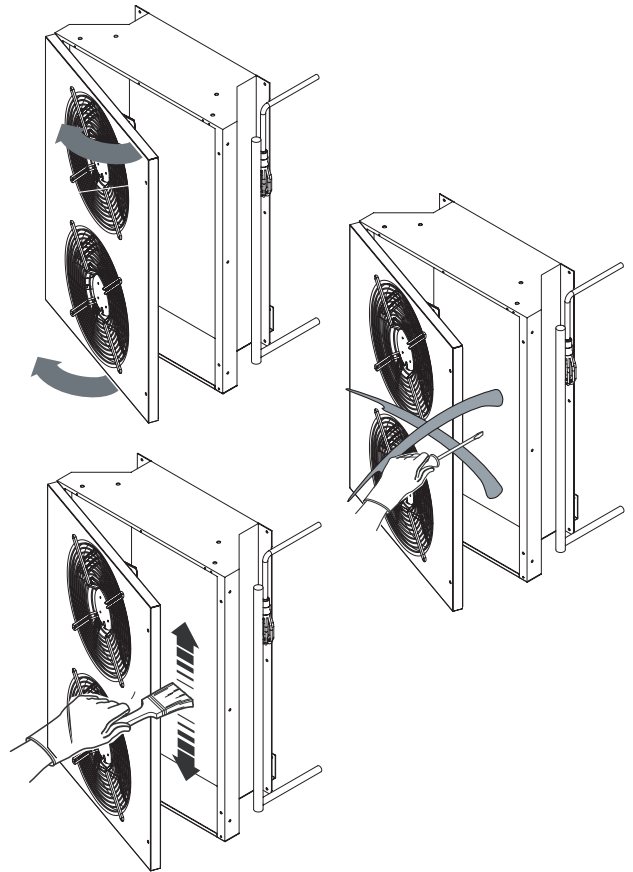

4.2.2. Condensate emptying

The models with condensing unit incorporated are equipped with a special basin for collecting condensate and washing water. It is positioned in the lower part of the item.

Periodically empty and clean the basin, sliding it out from under the equipment using the relevant handle.

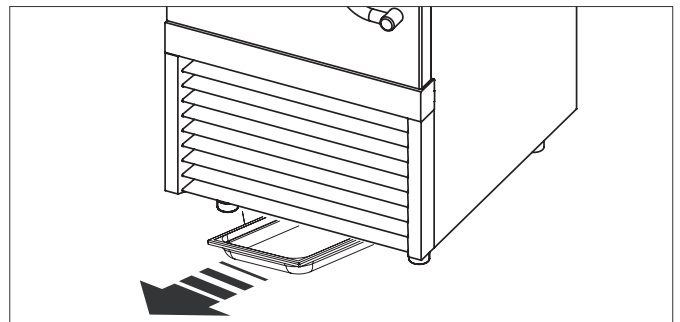

4.3. CLEANING THE CONDENSER

For the blast chillers with condensing unit incorporated, access the condenser by pulling the front finned grid. In the remote condensing unit it is necessary that the air cooled condenser is kept clean in order to allow the air to circulate freely.

This operation must be performed every 30 days maximum. It can be carried out using non-metal brushes in order to remove all of the dust and soot from the condenser fins themselves. The use of a suction device is recommended in order to prevent the dispersion of the dust removed into the environment. Whenever there are greasy deposits, use a brush soaked in alcohol.



Do not scrape the surfaces with sharp or abrasive bodies.



During the above-mentioned operations, always wear protective gloves, glasses and masks for protection of the respiratory tract.



Do not use water jets



Do not damage the refrigerant circuit.

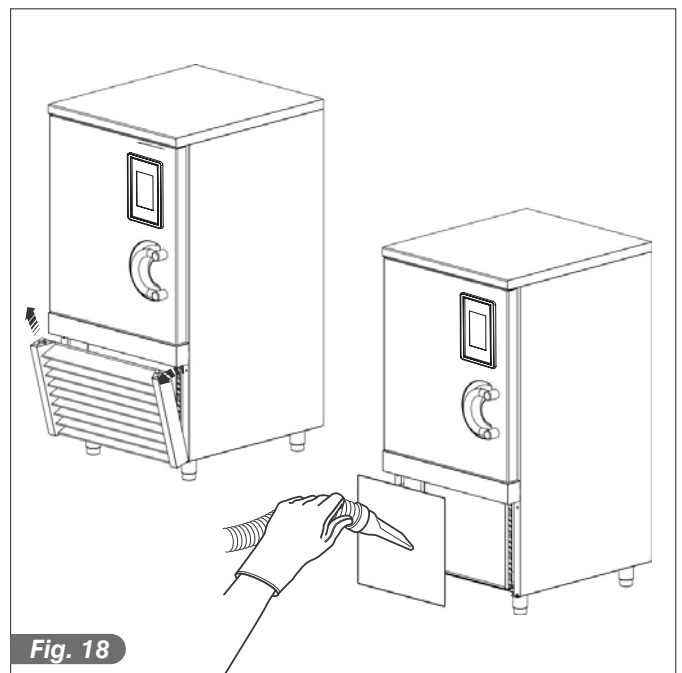

Fig. 18

4.4. TROUBLE SHOOTING

The machine electronic control is equipped with a visual system that indicates the presence of an alarm. The alarms are recorded in a list of alarms.

Diagnostics managed by the electronics:

- A window displays the type of alarm in progress
- In the case of several alarms at the same time, they will be displayed cyclically in a window
- Press the alarm field to view it

Alarm window	Description	Possible cause	Possible solution
PRESSURE SWITCH ALARM	High pressure alarm	High room temperature (over 35°C)	
		Condenser filter dirty	Clean the condenser
		Condenser fan broken	Technician intervention
		Peak condenser of the condenser fan fault	Technician intervention
		Condensation control pressure switch faulty (only for versions with remote unit or remote condenser)	Technician intervention
		High pressure pressure switch faulty	Technician intervention
		Excessive gas load in the plant	Technician intervention
		Compressor discharge cock closed	Open the compressor discharge cock
AIR PROBE FAULT	Chamber air probe faulty	Air probe fault	Replacement of air probe
CORE PROBE FAULT	Core probe fault	Breakdown of core probe	Replacement of the core probe
COMPRESSOR ALARM	Compressor circuit breaker alarm	The wire that annuls the alarm is disconnected	Control, using the wiring diagram: the wire between the CNIN-7 and CNIN-8 clamps is connected correctly.
EVAPORATOR DOOR OPEN	Evaporator door open alarm	The wire that annuls the alarm is disconnected	Control, using the wiring diagram: the wire between the CNIN-5 and CNIN-6 clamps is connected correctly.
DOOR OPEN	Door open alarm (except for during the defrost cycle)	The door is not closed correctly	Close the door by pushing it towards the chamber
		Micro switch fault, which controls the door closure	Technician intervention to replace the micro switch
		The micro switch wires are disconnected from the clamps	Insert the micro switch wires well into clamps 6 and 7 of the electric control board
Communication error	Communication alarm between display and power board	Communication cable disconnected	Check the communication cable and the connections
		Communication cable faulty	Replace the communication cable
check date/time	Clock lost synchronisation	Buffer battery flat	Replace the buffer battery

Diagnostics NOT managed by the electronics:

Malfunction	Possible cause	Possible solution
The front board does not switch on	No power supply	Check the connection to the electric line
	Bus Connector between the disconnected boards	Insert the Bus cable into the dedicated connector in the front board and in the Relay board
	Intervention of the protection fuses.	Replacement of the fuses by an authorised technician
The chamber fans do not turn	No power supply	Check the connection to the electric line
	Fan fault	Intervention of a technician for fan replacement
	Relay board fault	Intervention of a technician for fan replacement
The compressor does not function	No power supply	Check the connection to the electric line
	Intervention of the auxiliary circuit protection fuses	Fuse replacement by an authorised technician
	Intervention of the internal Klixson due to overloads	Technician intervention
	Intervention of a magnet circuit breaker switch	Intervention of a technician for re-arming the switch and checking calibration.
	Intervention of the high pressure switch	Control electronic diagnostics (ALP alarm). Technician intervention
	No Relay board consent	Intervention of a technician to replace the circuit board
	Remote control switch fault	Intervention of a technician to control the remote control switch
The compressor functions but does not cool the chamber	No refrigerant gas	Technician intervention
	Electrovalve fault	Technician intervention
	Dirty condenser	Clean condensing battery
	Liquid line electrovalve fault	Technician intervention for replacement of electrovalve or coil
The condenser fan does not function	No power supply	Check the connection to the electric line
	Pressure switch fault	Intervention of a technician for replacing the device
	Fan fault	Intervention of a technician for replacing the fan
	Peak condenser fault	Technician intervention for replacement of the peak condenser
	No compressor remote control switch consent	Intervention of a technician to control the compressor remote control
No evaporator defrost	Defrost cycle incorrect programming	Control defrost cycle programming

4.5. EXTRAORDINARY MAINTENANCE

The information and instructions in this paragraph are destined exclusively to the specialised staff authorised to intervene on the electric and refrigerator components of the machine.

4.5.1. How to access the front circuit board:

- Remove the power supply to the Blast Chiller
- Pull the steel frame from the plastic front panel on the door. The frame is fixed via a series of magnets.
- Loosen the Allen screws that fix the plastic front panel.
- The front panel can be extracted.
- The circuit board is fixed onto the rear of the front panel.



4.5.2. How to access the electric control board and the relay board:

- Remove the power supply to the Blast Chiller
- Pull the front finned grill with determination
- The electric box is on the left part of the blast chiller
- Loosen the screws that block the electric box and extract it by pulling it outwards, paying attention to accompany the rear bundle of cables
- Pull the lid to release it
- Access the electric control box and the relay board



4.5.3. How to access the condensing plant (where applicable):

- Remove the rear protection grid, loosening the screws with a flat screwdriver

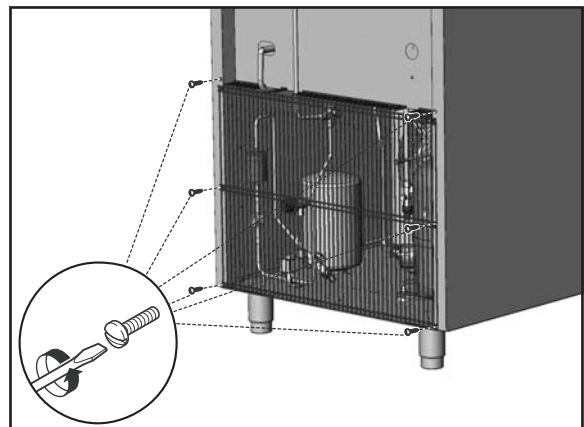



IRINOX

headquarter

via Madonna di Loreto, 6/B

31020 Corbanese di Tarzo (TV) - Italy

production site

via Caduti nei lager, 1

Z.I. Prealpi Trevigiane, loc. Scorigo

31015 Conegliano (TV) - Italy

P. +39 0438 2020

F. +39 0438 2023

irinox@irinox.com

www.irinoxprofessional.com