

SKOPE PEGASUS

PG Horizontal Series

1-1 and 2-1 Chillers and Freezers



PG200HC



PG500Prep



PG800Pizza



SKOPE Warranty Protection

To activate your Warranty Protection, you must register your product with SKOPE within 4 weeks from date of invoice.

To register online:

Visit our website at www.skope.com/warrantyprotection then complete and submit the online registration form.



Or alternatively contact our Customer Services team to register:

1800 121 535 (Australia)

0800 947 5673 (New Zealand)

SKOPE 1-year Extended Warranty

Extend your Warranty Protection by 1 year during registration. Please check you have not already organised an extended warranty through your dealer at time of purchase. For pricing information on an extended warranty visit www.skope.com/warrantyprotection

Service & Support

We know you will get years of satisfaction from your new SKOPE product when you follow a few simple preventative maintenance guidelines.

Helpful information is available on our website
www.skope.com/serviceandsupport



Thank you for purchasing a SKOPE refrigeration product.

Contents

1 Models

Undercounter	5
Prep	5
Pizza	5

2 Installation

Safety First	6
Positioning the Cabinet	6
Location	6
Ventilation	7
Power Supply	7
BMS Connectivity	8
Installing the Cabinet	8
Plinth Mounting	8
Legs and Castors	9
Shelving	10
Fitting the Shelves	10
Pans	10
Loading Product	10
Pans and Lids	11
Fitting the Lids	11
Remote Cabinets	12
Refrigeration Practice	12
Specifications	12
Drain	13
Electrical	13
Refrigeration Pipes and Solenoid	13
Installation Diagrams	14

3 Operation

Automatic Start-up	15
Refrigeration Cartridge	15
Electronic Controller	15
CAREL Controller	15
Dixell Controller	15
Pans and Lids	16
Electronic Controller	16
Controller Overview	16
Variations	16
SKOPE CAREL S4 EVO	16
Overview	16
Faceplate	17
Lights	17
Temperature Setpoint	17
Messages and Alarms	18
SKOPE CAREL ir33	19
Faceplate	19
Temperature Setpoint	20
Controller Alarms	20
Dixell XR75CX	22

Energy-saving Mode	22
Faceplate	22
Real Time Clock Function	22
On/Off Function	23
Manual Defrost	23
Temperature Records	23
Temperature Setpoint	24
Controller Lock	24
Controller Alarms	24
4 Servicing	
Mains Isolation	26
Cleaning	27
Cabinet	27
Condenser Coil	27
Pans and Air Diffusers	27
Lighting	28
Cabinet Interior Lights	28
Advanced Servicing	29
Refrigeration Cartridge Removal	29
Troubleshooting	31

1 Models

Undercounter

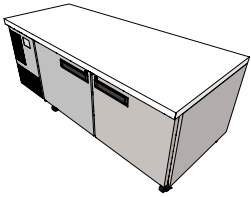
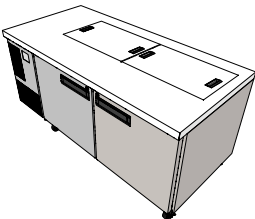

Table 1: Undercounter specifications

Model	Part No.	Configuration	Doors	Refrigeration cartridge	Operating temperature range
PG100HC-2	JH2301	1-1 fridge	1	Integral	Fridge +1°C to +4°C up to 43°C ambient
PG250HC-2	JH2302	1-1 fridge	2	Integral	
PG400HC-2	JH2303	1-1 fridge	3	Integral	
PG550HC-2	JH2304	1-1 fridge	4	Integral	
PG200HC	JK2301	2-1 fridge	1	Integral	
PG500HC	JK2302	2-1 fridge	2	Integral	
PG800HC	JK2303	2-1 fridge	3	Integral	
PG100HCr-2	JH3301	1-1 fridge	1	Remote	
PG250HCr-2	JH3302	1-1 fridge	2	Remote	
PG400HCr-2	JH3303	1-1 fridge	3	Remote	
PG550HCr-2	JH3304	1-1 fridge	4	Remote	
PG200HCr	JK3301	2-1 fridge	1	Remote	
PG500HCr	JK3302	2-1 fridge	2	Remote	
PG800HCr	JK3303	2-1 fridge	3	Remote	
PG100HF-2	JH1301	1-1 freezer	1	Integral	Freezer -18°C to -21°C up to 43°C ambient
PG250HF-2	JH1302	1-1 freezer	2	Integral	
PG400HF-2	JH1303	1-1 freezer	3	Integral	
PG500HF	JK1302	2-1 freezer	2	Integral	
PG100HFr-2	JH5301	1-1 freezer	1	Remote	
PG250HFr-2	JH5302	1-1 freezer	2	Remote	
PG400HFr-2	JH5303	1-1 freezer	3	Remote	
PG200HFr	JK5301	2-1 freezer	1	Remote	
PG500HFr	JK5302	2-1 freezer	2	Remote	



Prep

Table 2: Prep specifications

Model	Part No.	Configuration	Doors	Refrigeration cartridge	Operating temperature range
PG250Prep-2	JH7302	1-1 fridge	2	Integral	+1°C to +5°C up to 30°C ambient
PG400Prep-2	JH7303	1-1 fridge	3	Integral	
PG550Prep-2	JH7304	1-1 fridge	4	Integral	
PG500Prep	JK7302	2-1 fridge	2	Integral	
PG800Prep	JK7303	2-1 fridge	3	Integral	
PG250Prepr-2	JH8302	1-1 fridge	2	Remote	
PG400Prepr-2	JH8303	1-1 fridge	3	Remote	
PG550Prepr-2	JH8304	1-1 fridge	4	Remote	
PG500Prepr	JK8302	2-1 fridge	2	Remote	
PG800Prepr	JK8303	2-1 fridge	3	Remote	

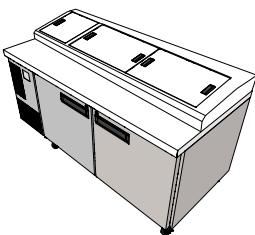

Pizza

Table 3: Pizza specifications

Model	Part No.	Configuration	Doors	Refrigeration cartridge	Operating temperature range
PG500Pizza	JK9302	2-1 fridge	2	Integral	+1°C to +5°C up to 30°C ambient
PG800Pizza	JK9303	2-1 fridge	3	Integral	
PG500Pizzar	JK6302	2-1 fridge	2	Remote	
PG800Pizzar	JK6303	2-1 fridge	3	Remote	

2 Installation

Safety First Always observe safety precautions when using any electrical appliance. Read these instructions carefully and retain them for future reference.

- This appliance is not intended for use by persons (including children) with reduced physical, sensory or mental capabilities, or lack of experience and knowledge, unless they have been given supervision or instruction concerning use of the appliance by a person responsible for their safety. Children should be supervised to ensure that they do not play with the appliance.
- Do **not** use this appliance for other than its intended use.
- Do not insert fingers/foreign objects into any holes.
- Only use this appliance with the voltage specified on the cabinet rating label.
- Ensure the appliance has adequate ventilation as this is essential to economical, high performance.
- Be careful not to touch moving parts and hot surfaces.
- For your own safety and that of others, ensure that all electrical work is done by authorised personnel.
- If the power supply flexible cord becomes damaged, it must be replaced by an authorised service agent or similarly qualified person in order to avoid a hazard.
- Ensure all necessary safety precautions are observed during installation or removal of the refrigeration unit.
- The appliance is not designed to be stable while in motion. Use extreme caution when moving or transporting it.
- Do not store explosive substances such as aerosol cans with a flammable propellant in this appliance.
- Do not exceed a maximum load of 20 kg per shelf.
- If the cabinet is to be scrapped, ensure the cabinet is unplugged from the power supply and cut off the mains flex close to the back of the cabinet. Be mindful of the risk of animals or children becoming trapped in the appliance – either remove or secure doors if necessary.
- Refrigerant must be removed by a qualified service person and the cabinet recycled/ disposed of in accordance with local regulations.

CAUTION

Never overload the power supply, which could damage the cabinet and product. See the rating label inside the cabinet for the safe power supply and current draw.

WARNING

Always disconnect the cabinet from the mains power supply before cleaning or maintenance.

Positioning the Cabinet

Location When positioning the cabinet, avoid direct sunlight and warm draughts. The cabinet must NOT be situated where it can be affected by warm or hot air from adjacent equipment, as this will compromise the airflow and performance of the cabinet.

The cabinet must be positioned on a level surface for the doors to shut and seal correctly, and to prevent the condensate tray from overflowing. Adequate allowance should be made for door opening.

Always ensure that the top of the cabinet is shielded from impact and moisture, with either a SKOPE-provided bench top, or with a custom or existing bench top.

Prep and Pizza fridges have pan openings with lids on the top of the cabinet. Maximum air movement around the opening area of the cabinet must not exceed 0.3 m/s. Excessive air movement will cause failure of the air curtain above the pans and excessive temperature rise.

When installing the cabinet

- Avoid direct sunlight and warm draughts.
- Allow adequate space for the door/s and/or drawer/s to open fully.
- Ensure the cabinet is positioned on a level surface so the door/s shut and seal correctly and to prevent the condensate tray from overflowing.
- Air movement above Prep and Pizza fridges must not exceed 0.3 m/s.

Ventilation For efficient operation of the cabinet, it is essential that adequate ventilation be provided around the front of the refrigeration cartridge. Normal operating conditions should not exceed the operating temperature range (see page 5).

It is critical that the hot refrigeration exhaust air is not restricted and that it can easily flow out and away from the front of the cabinet. Never store cardboard cartons or other items in front of the refrigeration cartridge. The ventilation slots on the cartridge front cover must be kept clear at all times.

Power Supply The cabinet is supplied with a flexible power cord and plug, which for transit purposes is located inside a compartment in the rear of the cabinet (see image below).

Before final positioning of the cabinet, pull the power cord out from the rear compartment and connect to the power supply. For convenience, any surplus cord length may be left inside the cabinet compartment.

WARNING:

Do **NOT** overload the power supply. See the rating label inside the cabinet for power supply and current draw.

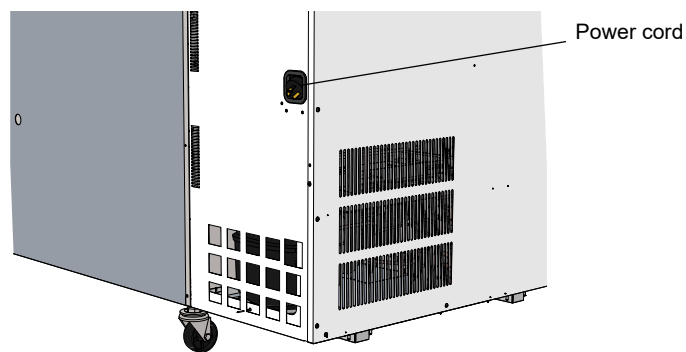

BMS Connectivity

Cabinets with the Dixell XR75CX electronic controller have RS485 ModBUS-RTU connectivity for connecting to an appropriate building management system (BMS). SKOPE recommends that you use either an optical isolator in the connection, or an RS485 to Wi-Fi converter to provide wireless connection.

Connect the RS485 serial line to terminals 16 (+), 17 (-) and 18 (GND) on the rear of the controller. Ensure any additional cables follow the same path as existing cables into the electronic controller enclosure.

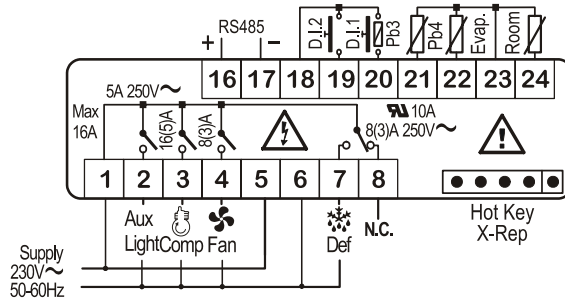

Dixell XR75CX electronic controller terminals

Follow the steps below to gain access to the terminals.

Procedure 1: To access the terminals at the rear of the controller

1. Open the refrigeration cartridge cover and disconnect the cabinet from the power supply (see page 26).

2. Detach the electronic controller assembly from the refrigeration cartridge cover by undoing the two fixing screws.

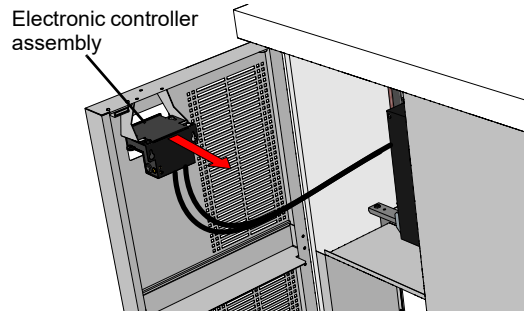

3. Undo the two controller enclosure screws to open the enclosure and gain access to the controller terminals.

Installing the Cabinet

The cabinet is supplied ready for plinth mounting or with adjustable legs and castors to support the cabinet.

Plinth Mounting 1-1 cabinets are supplied with leg/castor mounting plates on the bottom of the cabinet. Before mounting the cabinet, remove the mounting plates by unscrewing the fixing bolts (4 per mounting plate) to provide a flat surface on the bottom of the cabinet.

2-1 cabinets should be specified as either plinth-mounted or leg/castor-mounted when ordered. 2-1 plinth mount cabinets have a flat base and are fitted with a plinth surround, ready for positioning in place.

When installing plinth-mounted remote refrigeration cabinets, refer to separate technical installation and specification documentation (SKOPE part number: PRN10712).

Legs and Castors 1-1 cabinets and 2-1 leg/castor mount cabinets are packed with a set of adjustable height legs and a set of adjustable height castors. Either of these sets can be fitted to the cabinet depending on specific height and manoeuvrability requirements. The legs or castors should be fitted to the base of the cabinet before final installation.

The adjustable legs screw into the castor mounting plates attached to the bottom of the cabinet. The adjustable legs can adjust the cabinet height up to 30 mm.

Procedure 2: To adjust leg height

1. Turn the black plastic foot at the bottom of the leg:
 - anticlockwise to raise the height.
 - clockwise to lower the height.

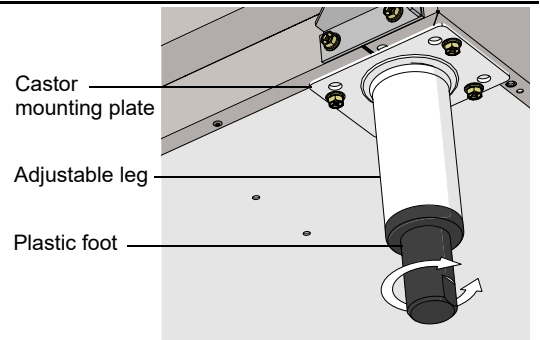

The adjustable castors screw into the castor mounting plates attached to the bottom of the cabinet. The two lockable castors should be fitted to the front of the cabinet and the non-locking castors fitted to the rear. The adjustable castors can adjust the cabinet height up to 15 mm.

Procedure 3: To adjust castor height

1. Loosen the lock nut.
2. Turn the castor counter-clockwise to raise the height or clockwise to lower.
3. Re-tighten each lock nut after the final adjustments have been made.

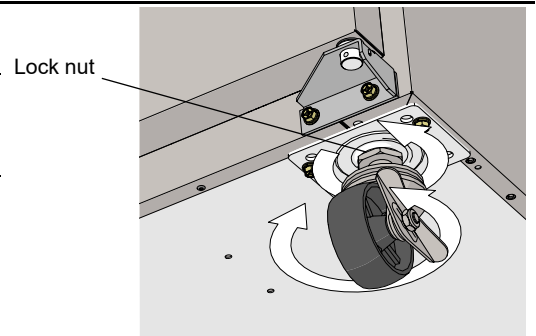

Shelving

Fitting the Shelves The cabinet is supplied with two sets of shelves and shelf support brackets per door. The shelves can be positioned at different heights to suit various products.

Procedure 4: To fit the shelves

1. Unpack the shelving items from inside the cabinet.
2. Establish the required position for each of the shelves, based on the height of the product intended to go on each shelf.

3. Fit the shelf support brackets into the corresponding slots in both the front and back support strips. Each shelf requires two support brackets.

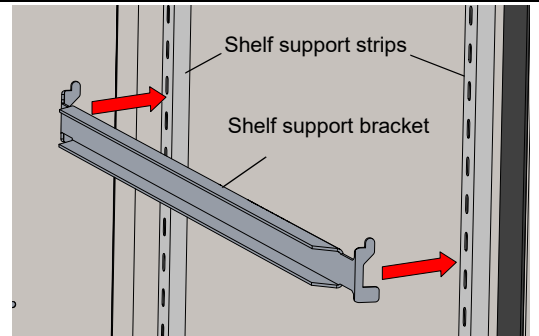

4. Slide each shelf into the support brackets.

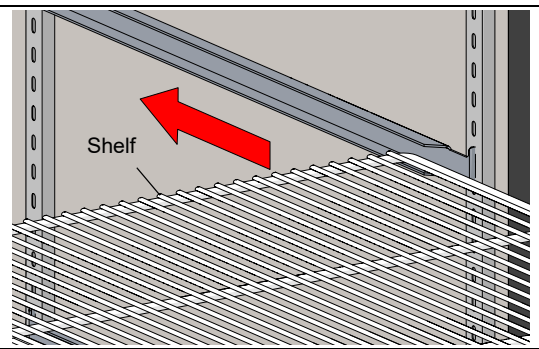

Pans The shelf support brackets can also hold Gastronorm pans. To store pans, remove the shelves and slide the pans into the shelf support brackets.

Loading Product The cabinet should be left running for 30 minutes before loading with product.

When loading product

- Allow air space around all the product to ensure even cooling and efficient operation of the cabinet.
- Do not allow products to hang over the front of the shelf as this could prevent the doors from shutting. Leave an airspace of at least 75 mm above product loaded on the top shelf.
- Do not exceed a maximum loading of 20 kg per shelf.
- Remove some product if the shelves are flexing or bending.

Pans and Lids

Prep and Pizza cabinets are supplied with food preparation pans and sliding lids which fit into openings on top of the cabinet.

For correct operation of the cabinet, the sliding lids must stay closed on the cabinet and should cover the food preparation pans when not in use.

IMPORTANT

Sliding lids must be in place when pans not in use. Leaving the lids off for extended periods will compromise performance of the cabinet.

Prep and Pizza cabinet operating temperature range is +1°C to +5°C for up to four hours in 30°C ambient with the lids off.

Refer to the tables below for standard pan and lid quantities.

Table 4: Prep cabinet

Model	Doors	Pans	Lids		
			Large	Small	Ambient
PG250Prep-2	2	4 × 1/3 150 mm deep refrigerated pans	-	2	-
PG400Prep-2	3	7 × 1/3 150 mm deep refrigerated pans	1	2	-
PG550Prep-2	4	10 × 1/3 150 mm deep refrigerated pans	2	2	-
PG500Prep	2	7 × 1/3 150 mm deep refrigerated pans	1	2	-
PG800Prep	3	11 × 1/3 150 mm deep refrigerated pans	3	1	-

Table 5: Pizza cabinet

Model	Doors	Pans	Lids		
			Large	Small	Ambient
PG500Pizza	2	7 × 1/3 150mm deep refrigerated pans, 2 × 1/3 65mm deep ambient pans	1	2	1
PG800Pizza	3	11 × 1/3 150mm deep refrigerated pans, 2 × 1/3 65mm deep ambient pans	3	1	1

Fitting the Lids Fit the lids into the removable rails in the well, and alternate them between the bottom (in the rail channel) and top (on top of the rail). Orientation of the lids is important. Ensure the notched ends meet on the inside to prevent any fingers jamming. See over page for fitting instructions.

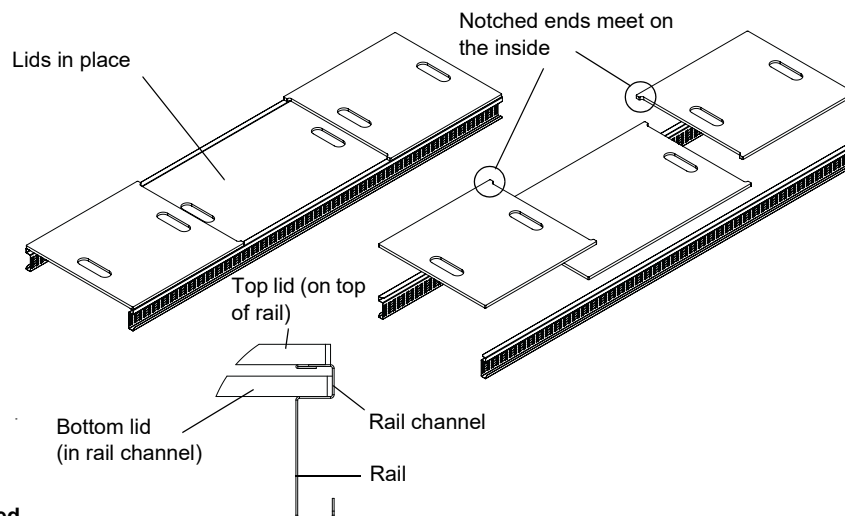

PG500Prep pictured

Procedure 5: To fit sliding lids

1. Lift the rails from the well, leaving the ends resting on one side of the cabinet top.
2. Configure the lids as required with the notched ends meeting on the inside, and slide the lower lids into the rails.

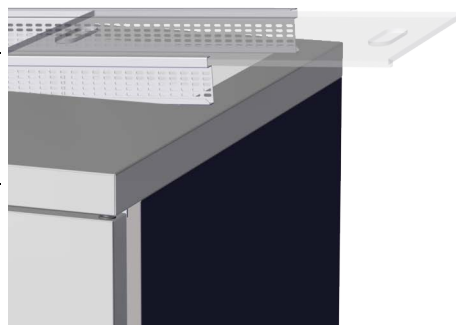

- Orientation of the lids is important.
3. Ensure the notched ends meet on the inside to prevent any fingers jamming.

4. Lower the rails and lower lids fully into the well so that they sit on the outside of the pan edges, and place the remaining lids on top of the rails.

Remote Cabinets

Refrigeration Practice Installation must be performed by a refrigeration tradesperson, to an appropriate standard complying with all local regulations.

Performance depends on the overall installation (including the condensing unit). Cabinet suitability must always be quantified for the application. The final responsibility for condensing unit performance and component selection rests with the installer.

The installer **must** check matters such as:

- Heat and refrigeration load.
- Variable operating conditions (usage, ambient and humidity).
- Refrigeration pipe sizing and length (distance, elevation and pressure drop).
- Location and ventilation (cabinet and condensing unit).
- Drainage and power supply.
- Fully evacuating the unit prior to charging.

Specifications

Table 6: Pegasus horizontal 1-1

Model	Refrigeration duty	Max. ambient temperature	Mean product temperature	Condensing temperature	Liquid temperature	Evaporating temperature (SST)	Operation basis
PG100HCr-2	210 watts	43°C	3.5°C	45°C	40°C	-5°C	18 / 24 hours
PG250HCr-2	360 watts	43°C	3.5°C	45°C	40°C	-5°C	18 / 24 hours
PG400HCr-2	485 watts	43°C	3.5°C	45°C	40°C	-5°C	18 / 24 hours
PG550HCr-2	630 watts	43°C	3.5°C	45°C	40°C	-5°C	18 / 24 hours
PG100HFr-2	230 watts	43°C	-18°C	45°C	40°C	-30°C	18 / 24 hours
PG250HFr-2	385 watts	43°C	-18°C	45°C	40°C	-30°C	18 / 24 hours
PG400HFr-2	550 watts	43°C	-18°C	45°C	40°C	-30°C	18 / 24 hours
PG250Prepr-2	500 watts	30°C	3.5°C	45°C	40°C	-5°C	18 / 24 hours
PG400Prepr-2	980 watts	30°C	3.5°C	45°C	40°C	-5°C	18 / 24 hours
PG550Prepr-2	1180 watts	30°C	3.5°C	45°C	40°C	-5°C	18 / 24 hours

Table 7: Pegasus horizontal 2-1

Model	Refrigeration duty	Max. ambient temperature	Mean product temperature	Condensing temperature	Liquid temperature	Evaporating temperature (SST)	Operation basis
PG200HCr	447 watts	43°C	3.5°C	45°C	40°C	-10°C	18 / 24 hours
PG500HCr	534 watts	43°C	3.5°C	45°C	40°C	-10°C	18 / 24 hours
PG800HCr	599 watts	43°C	3.5°C	45°C	40°C	-10°C	18 / 24 hours
PG200HFr	180 watts	43°C	-18°C	45°C	40°C	-30°C	18 / 24 hours
PG500HFr	364 watts	43°C	-18°C	45°C	40°C	-30°C	18 / 24 hours
PG500Prepr	706 watts	30°C	3.5°C	45°C	40°C	-10°C	18 / 24 hours
PG800Prepr	706 watts	30°C	3.5°C	45°C	40°C	-10°C	18 / 24 hours

Drain A 350 mm long, 19 mm O.D. PVC drain hose is supplied. All drainage must conform to local regulations, covering removal of condensate to waste water. Ensure the cabinet is level and the drain is trapped with adequate fall. Venting the drain may be required for a restrictive run. Use rigid PVC pipe for the drain and ensure the drain has a minimum fall of 50 mm per metre of drain length.

Electrical The cabinet is supplied with a 10 A flexible power cord and 3-pin plug. The cabinet lighting and centre pillar heater elements are protected by a 3 A fuse, located in the cartridge junction box.

Once the cabinet has been installed it can be disconnected from the mains power supply by turning off the cabinet isolation switch and unplugging the refrigeration cartridge supply isolation flexible cord, located inside the refrigeration cartridge compartment (see the diagram below).

Refrigeration Pipes and Solenoid A 1/4" liquid line and a 3/8" suction line are provided to attach pipes to. The suction line must be insulated.

The electronic controller supplied with the cabinet can switch a solenoid. No solenoid is supplied with the standard remote cartridge. If a solenoid is fitted and controlled by the electronic controller, the solenoid will need to be connected to the connector block inside the cartridge junction box.

Installation Refer to the diagrams for component locations and cartridge access points.

Diagrams Pegasus Horizontal 1-1 installation diagram

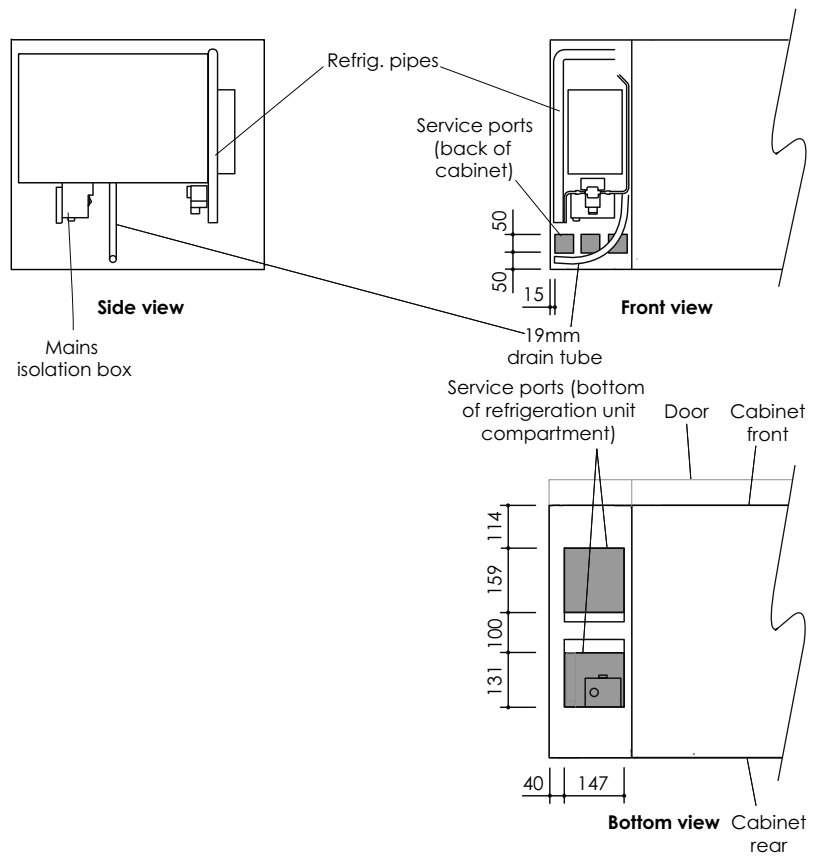

Pegasus Horizontal 2-1 installation diagram

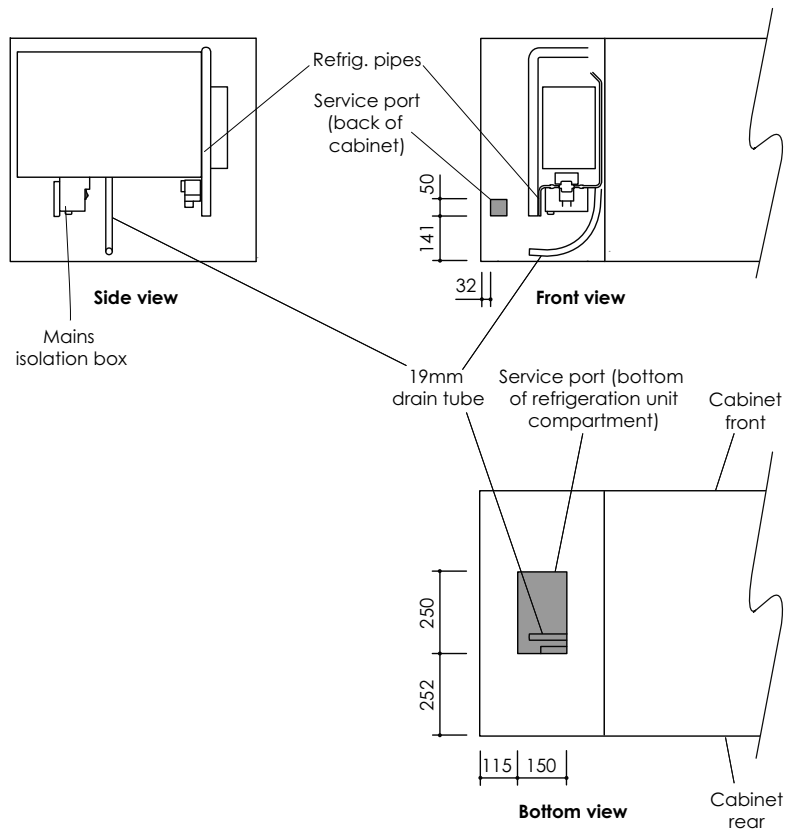

3 Operation





Automatic Start-up

Connect the cabinet to the mains power supply and check operation of the refrigeration cartridge and electronic controller.

Ensure the cabinet isolating switch, located inside the refrigeration cartridge compartment, is turned on (see “Mains Isolation” on page 26).

IMPORTANT

If the cabinet has been on its back, leave it for 30 minutes before running.

- Refrigeration Cartridge** The compressor, and the condenser and evaporator fans should all operate within two minutes from the time the cabinet is plugged in. You can verify this by listening for compressor switching on and checking for air movement inside the cabinet. The compressor and condenser fan will switch off when the cabinet internal air reaches a pre-set temperature.
- Electronic Controller** Depending on the date of manufacture, the cabinet will be fitted with a Dixell XR75CX controller, a CAREL ir33 controller, or a SKOPE customised CAREL S4 EVO controller. Check the label on top of the controller to verify the controller type.
To ensure efficient operation, the electronic controller forces regular defrosts. During the defrost cycle, the compressor and condenser fan switch off and the evaporator fan stays on.
- CAREL Controller** When the cabinet is connected to the power supply, the electronic controller will display the current cabinet temperature. The compressor LED  will indicate the compressor is operating and the evaporator fan LED  will normally come on within two minutes (see “Electronic Controller” on page 16 for controller display).
- HACCP (ir33 controller only)** If hazard analysis critical control (HACCP) functions are required, to monitor food storage temperature, please contact SKOPE to arrange for an authorised SKOPE service technician to set up the electronic controller.
- Dixell Controller** When the cabinet is connected to the power supply, the electronic controller will show current cabinet temperature. The compressor will start, (shown by the  symbol), and the fans will normally come on within two minutes (shown by the  symbol). See “Electronic Controller” on page 16 for controller display symbol information.
If the electronic controller display flashes between the current temperature and **rtc**, you need to set the real time clock, see “Real Time Clock Function” on page 22.

Pans and Lids

For correct operation of Prep and Pizza fridges, the pan lids must stay on the cabinet and should cover the food preparation pans when not in use. The maximum recommended operating ambient temperature for Prep and Pizza fridges is 30°C.

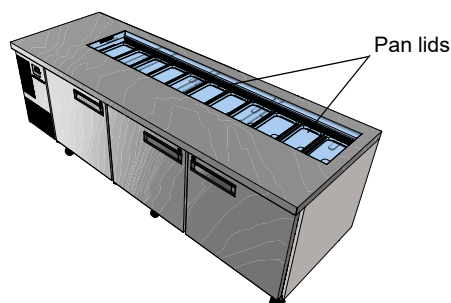

IMPORTANT

Lids or sliding covers must be in place when the pans are not in use. Leaving the lids off for extended periods will compromise the performance of the cabinet.

Electronic Controller

Controller Overview The electronic controller controls and displays the internal cabinet temperature. The preset temperature setting keeps the product temperature within the operating temperature range (see page 5). The electronic controller also signals temperature alarms.

For general operation, the electronic controller requires no initial setup or additional programming, and SKOPE does not recommend that settings be changed unless it is absolutely necessary.

Open the refrigeration cartridge door to access to electronic controller for programming.

Note: On 2-1 cabinets the controller must also be unhooked from the refrigeration cartridge door to access the buttons.

Variations Cabinets manufactured:

- before September 2022 use a CAREL ir33 or a Dixell XR75CX electronic controller.
- after September 2022 use a CAREL S4 EVO or a Dixell XR75CX electronic controller.

Check the label on top of the controller to verify the controller type.

SKOPE CAREL S4 EVO

Overview The CAREL S4 EVO electronic controller is visible through a cut-out in the cabinet's front panel. The electronic controller is pre-programmed and requires no initial set-up or additional programming. SKOPE does not recommend that the settings be changed unless absolutely necessary.

CAUTION

The electronic controller must only be adjusted by an authorised service agent.

To achieve energy efficient operation, the electronic controller uses temperature probes to control and display the cabinet's temperature, collect data, indicate temperature alarms, and force a defrost cycle when required.

Faceplate Because the electronic controller plays such an important role, it's helpful to know the parts of the faceplate you may use.

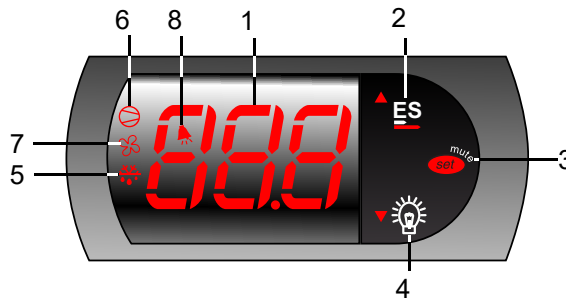

Table 8: CAREL S4 EVO faceplate

No.	Item	Description
1		Digital display of cabinet temperature or messages. The temperature is what the sensor inside the cabinet detects, and not necessarily the product temperature. However, they may be very close, depending on how the controller is set to sense temperature.
2		Up: Button. Used for programming.
3		Mute (set): Button. Press to mute the alarm. Press and hold to access parameters.
4		Light (down): Button. Press to switch the cabinet interior light on and off.
5		Defrost: Indicator. On when the defrost is activated. Flashes when activating the defrost is temporarily delayed due to other procedures in progress.
6		Compressor: Indicator. On when the compressor and condenser fan starts. Flashes when activating the compressor is temporarily delayed.
7		Fan: Indicator. On when the internal cabinet fans are activated. Flashes when activating the fans is temporarily delayed.
8		Alarm: Indicator. On when the alarm is signalled.

Lights Press the Light button on the electronic controller faceplate to manually switch the cabinet light on and off.

Temperature Setpoint The temperature setpoint is set at the factory to 2.0°C, and can be adjusted between 1.0°C and 3.5°C for other specialist applications if required.

SKOPE does not recommend changing the setpoint unless it is absolutely necessary, and then only by small increments at a time.

Procedure 6: To view and adjust the temperature setpoint for the CAREL S4 EVO

1. Press and hold the **set** button for 3 seconds until **PS** is shown on the display, indicating entry into the controller settings menu.



2. Press the **up** or **down** button to scroll through the menu until **St** is shown on the display.



3. Press the **set** button.
The current setpoint value shows on the display.

Procedure 6: To view and adjust the temperature setpoint for the CAREL S4 EVO

4. Press the **up** or **down** button to increase or decrease the setpoint value to the required temperature.
5. Press the **set** button to temporarily save the setpoint value.
6. Press and hold the **set** button for 3 seconds to permanently save the setpoint value and exit the controller settings menu.

Messages and Alarms

The following tables explain the messages and alarms that the electronic controller displays.

Table 9: CAREL S4 EVO messages

Display	Description
20	The cabinet is in "Normal" mode and the electronic controller displays the temperature.
--	The cabinet's internal temperature is above 13°C.
CCP	The cabinet is in cold climate protection (CCP) mode. The cabinet enters CCP mode if the room's ambient temperature gets too cold. The lights remain on and cannot be switched off.

Table 10: CAREL S4 EVO alarms

Display	Description	
E0	Probe fault. An alarm sounds. Contact a service agent.	
E1		
E2		
L0	Low temperature alarm. An alarm sounds. The temperature inside the cabinet is too cold. The controller will automatically reset the alarm once the temperature inside the cabinet rises.	
H1	High temperature alarm. An alarm sounds. The temperature inside the cabinet is too warm. The controller will automatically reset the alarm once the temperature inside the cabinet drops.	
cht	Refrigeration system high temperature Pre-warning (auto reset)	<ol style="list-style-type: none"> 1. Check the cabinet's ventilation and ensure that it is installed in a suitable environment (see page 5). 2. To reset the "CHt" alarm, unplug the cabinet from the power supply for 1 minute, then reconnect to power supply. 3. If the alarm persists, contact a service agent.
CHt	Refrigeration system high temperature Shutdown (manual reset)	
EL0	Low voltage alarm. An alarm sounds. The mains voltage is low. The controller switches off the compressor. The controller will automatically reset the alarm once the mains voltage rises.	
EH1	High voltage alarm. An alarm sounds. The mains voltage is high. The controller switches off the compressor. The controller will automatically reset the alarm once the mains voltage drops.	
EE	Electronic controller fault. Contact a service agent.	
EF		

SKOPE CAREL ir33

Faceplate

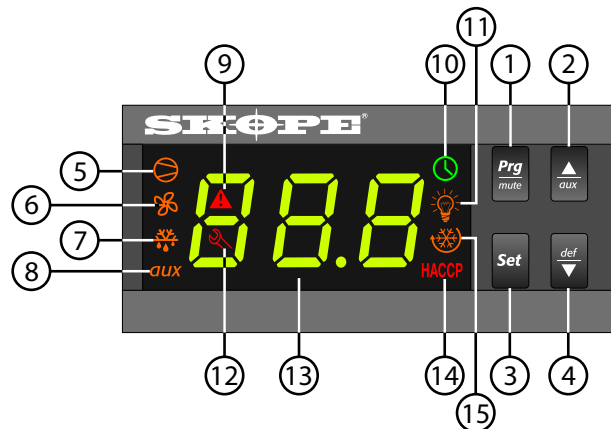

Table 11: CAREL ir33 faceplate

Item	Icon	Function
1	<i>Prg</i> <i>mute</i>	Mute / program: Mutes the audible alarm (buzzer) and deactivates the alarm relay. To initiate program sets, press for 5 seconds.
2	▲ <i>aux</i>	Up: To scroll settings up (in program mode).
3	<i>Set</i>	Setpoint: If pressed for more than 2 seconds displays and / or enables changing the temperature setpoint.
4	▼ <i>def</i>	Manual defrost / down: Press for more than 5 seconds to initiate manual defrost. To scroll settings down (in program mode).
5	⊘	Compressor: ON when the compressor and condenser fan starts. Flashes when activation of the compressor is temporarily delayed.
6	⊙	Fan: Shows when the fan is operational.
7	❄	Defrost: ON when the defrost is activated. Flashes when the activation of the defrost is temporarily delayed due to procedures in progress.
8	<i>aux</i>	Aux: n.a.
9	⚠	Alarm: Flashes in the event of alarms.
10	🕒	Clock: n.a.
11	💡	Light: n.a.
12	🔧	Service: Flashes in the event of malfunctions.
13	88.8	DISPLAY: Shows the cabinet temperature. Flashes when the door is open.
14	HACCP	HACCP: n.a.
15	🔄❄	CONTINUOUS CYCLE: On when cabinet is running in continuous run mode.

Temperature Setpoint

The cabinet temperature setpoint is set at the factory, and can be adjusted if necessary.

SKOPE does not recommend changing the setpoint unless it is absolutely necessary, and then only by small increments at a time.

Procedure 7: To view and adjust the temperature setpoint for the CAREL ir33

1. To view the setpoint:

Press and hold the **Set** key for 2 seconds, until the setpoint value flashes.

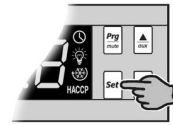

2. To adjust the setpoint:

Press either the $\frac{\Delta}{aux}$ or $\frac{def}{\nabla}$ keys to display the required setpoint value.

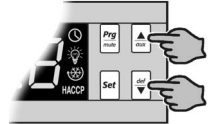

3. Press the **Set** key again to assign the new setpoint value. If you do not press the key within 60 seconds your changes will be lost and you will need to repeat the procedure.















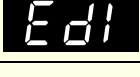
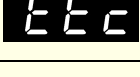

Controller Alarms

The following table explains messages and related alarms that the electronic controller displays. Alarms signal unexpected operational changes in the cabinet and stop when action is taken to resolve the problem.

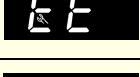
Table 12: CAREL ir33 controller alarms

Code	Display	Alarm	Action
HI	Flashing	Product HIGH temperature alarm (auto reset)	1. Check the cabinet product loading to ensure that the ventilation slots are not blocked, and that product is not hanging over the shelves. Ensure the doors are closed.
LO	Flashing	Product LOW temperature alarm (auto reset)	2. Ensure the cabinet is installed with good refrigeration cartridge ventilation. 3. Check and clean the condenser coil (see page 27). 4. If immediate alarm recovery is required, unplug the cabinet from the power supply for 1 minute, then reconnect to power supply. If the alarm persists, contact SKOPE. NOTE: The "HI" and "LO" alarms deactivate the cabinet lighting and trim heaters.
cht	Flashing	Refrigeration system high temperature pre-warning (auto reset)	1. Clean the condenser coil (see page 27). 2. Check refrigeration ventilation. Ensure that there is a clear airpath in front of the cabinet.
CHT	Flashing	Refrigeration system and cabinet high temperature shut down (manual reset)	3. Ensure that the cabinet is installed in a suitable environment. 4. To reset the "CHt" alarm, unplug the cabinet from the power supply for 1 minute, then reconnect to power supply. If the alarm persists, contact SKOPE.

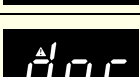
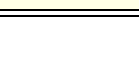
Table 12: CAREL ir33 controller alarms (continued)

	 Flashing	Ambient probe fault (also flashes "rE")	1. To reset the alarm, unplug the cabinet from the power supply for 1 minute, then reconnect to the power supply. 2. If the alarm persists, contact SKOPE.
	 Flashing	Evaporator probe fault	
	 Flashing	Condenser probe fault	
	None	Defrost over-time limit	
	 Flashing	Real-time clock fault	
	 Flashing	Controller E prom error	
	 Flashing	Controller E prom error	
	None	Start defrost request	None
	None	End defrost request	
	 Flashing	Door open alarm	Check that a door or drawer has not been left open. Note: The audible alarm buzzer cannot be turned off manually.

Dixell XR75CX

Energy-saving Mode The electronic controller can be programmed to run in energy-saving mode at specified times. When in energy saving mode the cabinet interior temperature is elevated, which may not be suitable for all applications. Contact a SKOPE service agent to set this up.

Faceplate

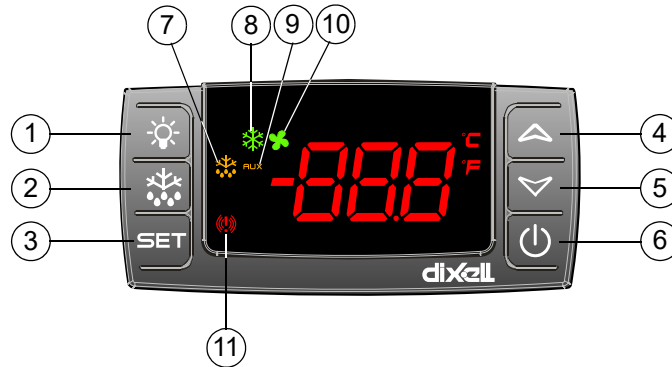











Table 13: Dixell XR75CX faceplate

Item	Icon	Function
1		Light button: n.a.
2		Defrost button: To manually initiate a defrost cycle.
3		Set button: To display the temperature setpoint, reset the highest and lowest recorded temperatures and change the setpoint.
4		Up button: To view the highest temperature recorded inside the cabinet.
5		Down button: To view the lowest temperature recorded inside the cabinet.
6		On/Off button: To switch the cabinet off and on.
7		Defrost cycle indicator: On during defrost cycles. Flashes during drip time (e.g. after a defrost cycle).
8		Compressor indicator: On when the compressor is on. Flashes in the event of a prolonged fan cycle (e.g. after power up or a short defrost cycle).
9		Auxiliary indicator: On when auxiliary relay is on.
10		Fan indicator: On when the fans are on.
11		Alarm indicator: On when an alarm is occurring.
12		Real time clock indicator: On when the real time clock needs to be set.

Real Time Clock Function Only applicable when the real time clock function is available. When first powered up, or when powered up after being disconnected from the power supply for 24 hours or longer, the real time clock alarm will activate and the real time clock time and day will need to be set. Follow the steps below to set the real time clock.

Procedure 8: To set the real time clock for the Dixell controller

1. Press and hold the **SET** and  buttons for three seconds. **rtc** is displayed.
2. Press the **SET** button. **Hur** (hour) is displayed.
3. Press the **SET** button, then use the  and  buttons to set the current hour.
4. Press the **SET** button to save the hour. **Min** (minute) is displayed.
5. Press the **SET** button, then use the  and  buttons to set the current minute.
6. Press the **SET** button to save the minute. **day** (day of the week) is displayed.
7. Press the **SET** button, then use the  and  buttons to set the current day.
8. Press the **SET** button to save the day. **rtc** is displayed, and the real time clock is set.
9. To exit, press the **SET** and , or wait 15 seconds.

On/Off Function When the on/off function is enabled, the cabinet can be switched off and on by pressing the  button on the controller faceplate. Contact a SKOPE service agent if this function is required.

When switched off, the electronic controller enters standby mode and turns off the refrigeration system, and **OFF** is displayed on the electronic controller faceplate.

Ensure compliance with all food safety requirements. If perishable product is being stored in the cabinet, don't turn it off.

Manual Defrost A manual defrost may be necessary if the door is left open for an extended period of time or during abnormal environmental conditions.

To initiate a manual defrost, press and hold the  button for five seconds.

Temperature Records The electronic controller records the highest and lowest cabinet internal temperatures.



Procedure 9: To view the highest temperature recorded for the Dixell controller

1. Press and release the  button. The highest temperature is displayed.

Procedure 10: To view the lowest temperature recorded for the Dixell controller

1. Press and release the  button. The lowest temperature is displayed.

Procedure 11: To reset the temperature records for the Dixell controller



1. Press and release the  or  button to display the highest or lowest temperature recorded.
2. While the highest or lowest recorded temperature is displayed, press and hold the **SET** button for three seconds. **rSt** is displayed and the temperature records are reset.

Temperature Setpoint The cabinet’s temperature setpoint is set at the factory, and can be adjusted if necessary. SKOPE does not recommend changing the setpoint unless it is absolutely necessary, and then only by small increments at a time.

Procedure 12: To view the temperature setpoint for the Dixell controller



1. Press and release the **SET** button. The setpoint is displayed.

Procedure 13: To adjust the temperature setpoint for the Dixell controller



1. Press and hold the **SET** button for two seconds. The current setpoint is displayed and °C or °F flashes.
2. Use the  and  buttons to adjust the setpoint.
3. Press and release the **SET** button or wait ten seconds to assign the new setpoint value.

Controller Lock The electronic controller buttons can be locked to prevent access to the controller settings. It is still possible to view the setpoint and temperature records when the electronic controller is locked.

Procedure 14: To lock the electronic controller

1. Press the  and  buttons simultaneously for three seconds. The controller displays **POF** and the controller is locked.

Procedure 15: To unlock the electronic controller

1. Press the  and  buttons simultaneously for three seconds. The controller displays **Pon** and the controller is unlocked.

Controller Alarms The following table explains messages that the electronic controller displays and related alarms. Alarms signal unexpected operational changes in the cabinet and stop when action is taken to resolve the problem.

Table 14: Dixell controller alarms











Code	Alarm	Action
	Probe alarm.	Press any button on the electronic controller to reset the alarm. If the alarm persists, arrange a service call.
		
		
		

Table 14: Dixell controller alarms (continued)

	Maximum temperature alarm	<p>Press any button on the controller to reset the alarm.</p> <p>The alarm will stop once the temperature has reached an acceptable level.</p>
	Minimum temperature alarm	<p>Check that the installation meets specification. Ensure there are no blockages in front of or behind the cabinet, and that the cabinet is installed within the operating temperature range.</p> <p>If the alarm persists, arrange a service call.</p>
	Condenser high temperature alarm	<p>Clean the condenser coil and press any button on the controller to reset the alarm.</p> <p>The alarm will stop once the condenser temperature has reached an acceptable level.</p> <p>Check that the installation meets specification. Ensure there are no blockages in front of or behind the cabinet, and that the cabinet is installed within the operating temperature range.</p> <p>If the alarm persists, arrange a service call.</p>
	Door open alarm	<p>Close the door.</p> <p>If the alarm persists, arrange a service call.</p>
	Real time clock alarm	Press any button on the electronic controller to reset the alarm.
	Real time clock board alarm	If the alarm persists, arrange a service call.

4 Servicing

Mains Isolation

The cabinet can be isolated from the mains power supply by turning off the cabinet isolating switch and unplugging the unit supply plug, located inside the refrigeration cartridge compartment.

Procedure 16: To isolate the cabinet from the power supply

1. Open the cartridge cover.

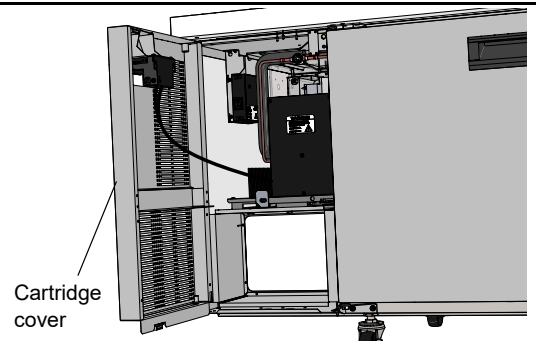

2. Switch off (O) the power at the isolation switch, located on the left hand side of the refrigeration cassette compartment, and unplug the unit supply plug.

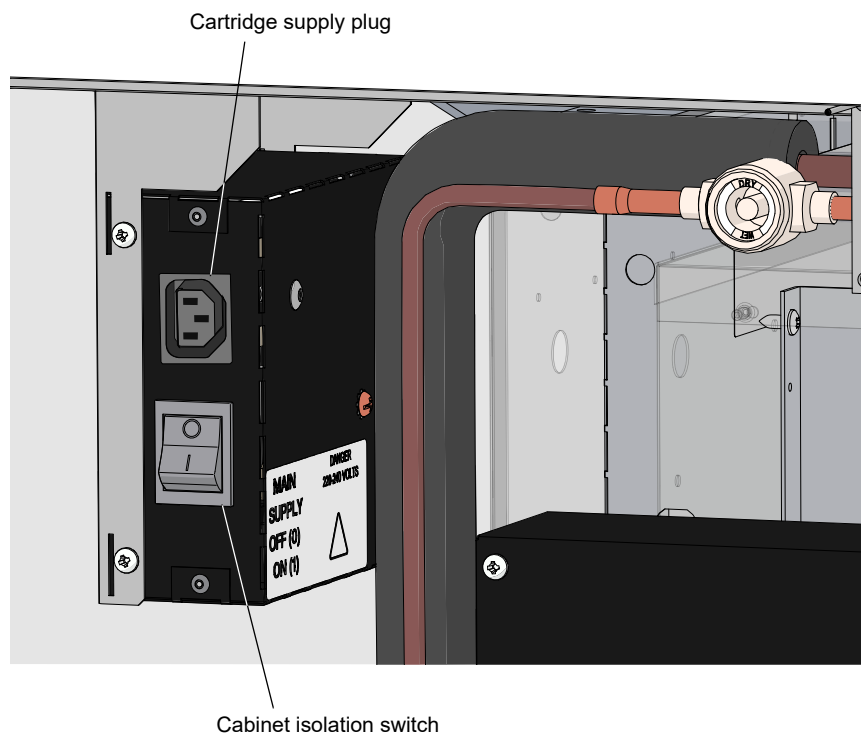

Cleaning

Ensure the cabinet is disconnected from the mains power supply before cleaning the cabinet.

Cabinet When necessary, wipe both the interior and exterior of the cabinet with a damp cloth.

CAUTION

Disconnect the cabinet from the mains power supply before cleaning the condenser coil or washing the cabinet with water.

Condenser Coil

Integral cabinets only
The condenser coil should be brushed clean once a month and blown clean by qualified service personnel every six months. Over time, dust may accumulate within the condenser that cannot be removed with a brush. If this occurs, contact SKOPE to arrange for a SKOPE-authorized service agent to clean the condenser with compressed air. The condenser coil is located inside the refrigeration cartridge compartment and is accessed by opening the unit front cover. Disconnect the cabinet from the power supply (see page 26) before cleaning the condenser coil.

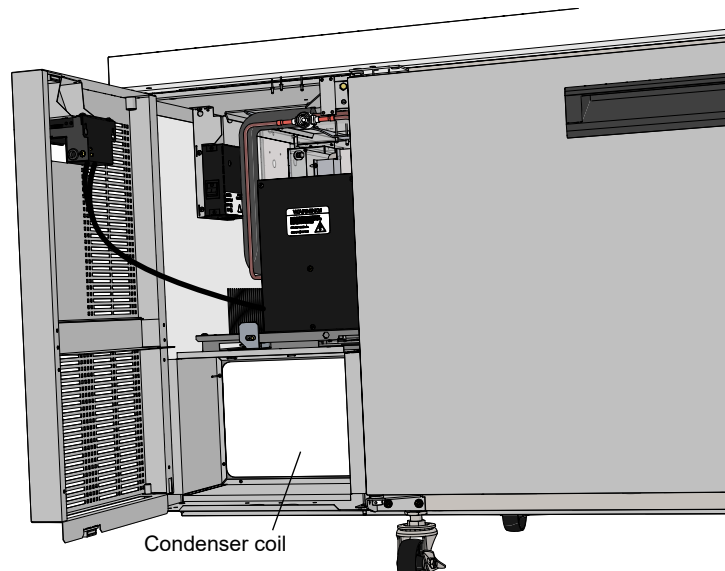

IMPORTANT

If the electronic controller display flashes "cht" the condenser coil must be cleaned immediately.

Pans and Air Diffusers

Prep and Pizza cabinets only
The food preparation pans and air diffuser panels can be easily lifted from the cabinet for cleaning.

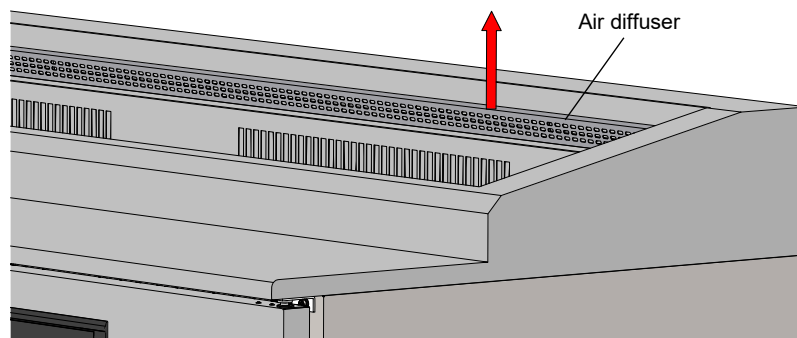

Lighting

Cabinet Interior Lights Pegasus 1-1 cabinets are fitted with door-activated cabinet interior lights. Depending on the cabinet size, the interior is lit by one or two 5 watt T8 LED tubes (Ø26 × 360 mm), fitted behind the centre pillars. The single door model, without a centre pillar, has the interior LED light tube fitted on the ceiling of the cabinet.

Note: Pegasus 2-1 cabinets are not fitted with interior lights.

Procedure 17: To replace the interior LED light tube

1. Isolate the cabinet from the power supply (see page 26).
-

2. Remove the diffuser by squeezing it until it is released from the housing, and then push the diffuser out of the way.

Multiple door cabinet pictured



3. Rotate the LED tube until the pins on the ends of the tube align with the slots, then slide it out. **Note:** access can be made easier by removing the shelves.
-

4. Fit a new LED tube and clip the diffuser back into place. When fitting vertically mounted LED tubes, ensure the tube is fitted with the "Power" end at the top.



Advanced Servicing

Advanced servicing should be carried out by an authorised service agent. Detailed service and spares information is available in the SKOPE Pegasus Service Manual (MAN10711) and detailed technical information on the CAREL ir33 electronic controller can be found in the SKOPE Pegasus Technicians' Manual (MAN3224).

Refrigeration Cartridge Removal

Integral cartridges only

For ease of servicing, the entire refrigeration cartridge can be removed.

Procedure 18: To remove the refrigeration cartridge

1. Open the cartridge cover and isolate the cabinet from the power supply.

2. Detach the electronic controller assembly from the cartridge cover by undoing the two fixing screws. Place the electronic controller on top of the condenser duct.

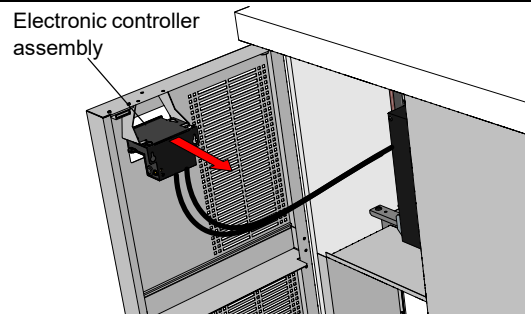

3. Remove the cartridge cover by lifting the bottom corner of the cover off the bottom hinge pin.

4. Disconnect the cabinet supply ENSTO plug.

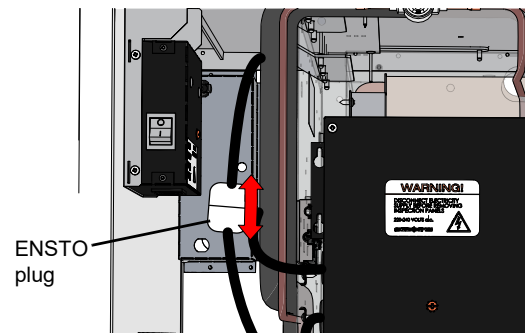

5. Remove the top clamp screw from the clamp mechanism on top of the cartridge (the screw is located on the left hand side of the cartridge compartment on 1-1 cabinets and the right hand side on 2-1 cabinets).

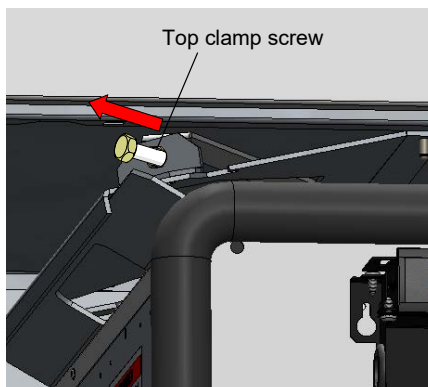

1-1 cabinet top clamp screw

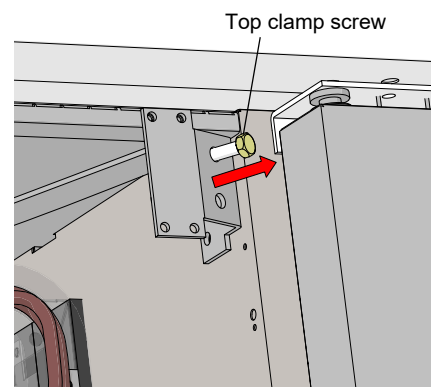

2-1 cabinet top clamp screw

Procedure 18: To remove the refrigeration cartridge (continued)

6. Pull the top clamp mechanism fully forward and to the left, so that it sits on the notch on the left hand side of the refrigeration cartridge compartment (this keeps the mechanism up out of the way).

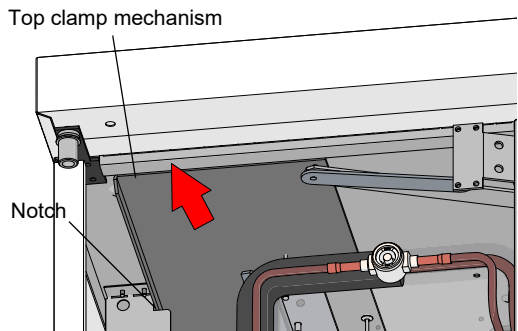

7. Remove the bottom clamp screw from the front of the refrigeration cartridge, and pull the bottom clamp lever out while applying adequate force to the right hand side of the wiring junction box to disengage the cartridge from the cabinet wall (the cartridge will need to move over approximately 60 mm).

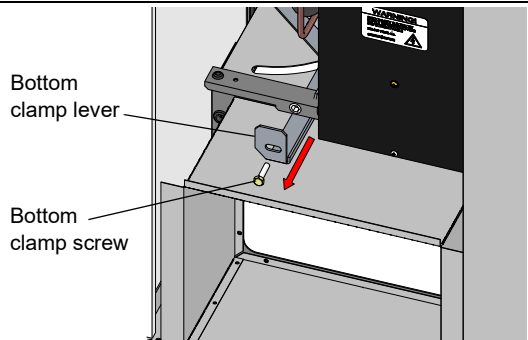

8. Carefully pull the refrigeration cartridge out from the cartridge compartment.

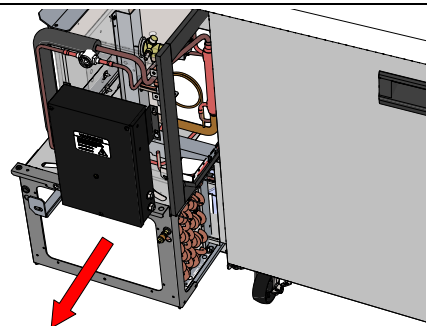

9. When refitting the refrigeration cartridge:
 - Ensure that all seals are in good condition.
 - Refit the bottom clamp screw first before fitting the top clamp screw, and ensure the lower edge of the cartridge base is engaged with the brace rail.

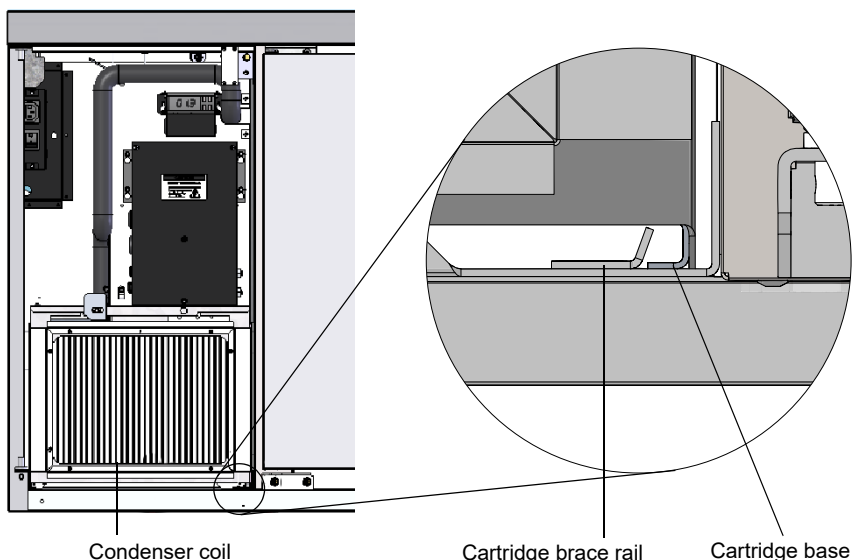

Troubleshooting

Table 15: Troubleshooting

Problem	Possible Cause	Repair
Cabinet not operating and no controller display	<ul style="list-style-type: none"> Loss of power supply. 	<ul style="list-style-type: none"> Check that the cabinet isolating switch is turned on (see page 26). Check the mains power supply.
Power consumption is higher than expected	<ul style="list-style-type: none"> Cartridge operating too hot. Cabinet doors are opened excessively. 	<ul style="list-style-type: none"> Clean the condenser. Ensure the cabinet is installed with good ventilation around the refrigeration cartridge. Keep door/s open for minimum time.
Product is too warm and spoiling	<ul style="list-style-type: none"> Restricted cabinet airflow. Temperature setpoint is too warm. 	<ul style="list-style-type: none"> Ensure product is not blocking the airflow slots and the product is no closer than 75 mm from the cabinet top. Adjust the setpoint (see page 20).
Warm cabinet temperatures and/or compressor operating for long periods (more than 1 hour)	<ul style="list-style-type: none"> Blocked condenser. Poor refrigeration cartridge ventilation. 	<ul style="list-style-type: none"> Clean the condenser (see page 27). Ensure the cabinet is installed with good ventilation around the refrigeration cartridge.

SKOPE Industries Limited

ABN: 73 374 418 306

AU: 1800 121 535

NZ: 0800 947 5673

skope@skope.com

www.skope.com

Trademark Infringement

The SKOPE trademark on this product is infringed if the owner, for the time being, does any of the following:

- Applies the trade mark to the product after its state, condition, get-up or packaging has been altered in any manner
- Alters, removes (including part removal) or obliterates (including part obliteration) the trade mark on the product
- Applies any other trade mark to the product
- Adds to the product any written material that is likely to damage the reputation of the trade mark

Notice of the above contractual obligations passes to:

- Successors or assignees of the buyer
- Future owners of the product

SKOPE Pegasus
PG Horizontal Series

User Manual
MAN10710

Rev. 2.3 Oct. 2022

© 2013 SKOPE Industries Limited. All rights reserved.

SKOPE Industries Limited reserve the right to alter specifications without notice.

SKOPE® is a registered trademark of SKOPE Industries Limited.