

Ice Cube Storage Bin & Transport System

SKOPE ID: SILO SCS300

Machine Dimensions: 762W x 1016 D x 1865 H (mm)

Packed Dimensions: 962 W x 1216 D x 2065 H (mm)

Weight: 95kg

Floor Area: 2.41m³

Storage Bin Capacity: 412kg (300kg in bin & 112kg in cart)

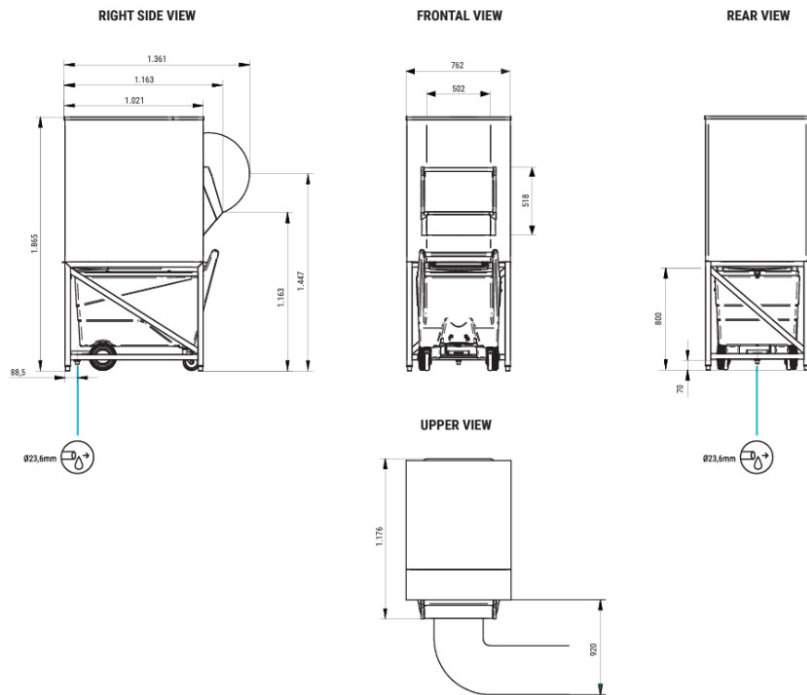

Description

The SILO SCS Series offers compact ice storage bin solutions for caterers and venues that need to cover a lot of distance fast. The SCS300 Ice Cube Storage Bin offers 300kg of capacity in its bin, plus up to 112kg of capacity in its cart. The bin design benefits service delivery by helping you avoid ice spills and speeding up the transfer of ice to drinks, while the cart helps you transfer ice to different stations with less effort. Strong solid AISI 304 stainless steel box-type frame. Hard sanitary polyethylene vat, resistant to blows, and scratches. Easy cleaning design: seamless one-piece vat with rounded corners, avoiding possible dirty points and facilitating cleaning. Drainage system that collects and drives the water to the drain keeping the bin and floor clean & dry. Large capacity easy cart, up to 112kg of ice (70kg with buckets); ergonomic, easy to move with little effort. Easy cart has a braking and drainage system. Easy cart is made of sanitary polyethylene, with smooth surface to facilitate cleaning. It includes a cover to prevent dirt from contaminating the ice. Filter systems need to be installed with the ice machine to protect the 2-year parts and Labour warranty. Best suited to: Restaurants / Cafes, Clubs / Pubs / Bars, Quick Service Restaurants, Convenience / Petrol / Supermarkets, Food Production, Hospitality / Venues, Accommodation, Schools, Medical / Aged Care, Bakery / Pastry.

Supplied Accessories



Drain Hose



Large Scoop



Ice Paddle



Ice Paddle Support



Warranty



Watermark

A Watermark approved* water filter, suitable for the water type at the place of installation must be used. SKOPE can provide a water filter that protects the Ice Maker, and ensures proper function and high quality ice production. Service or repair due to absence of a suitable water filter will not be covered by SKOPE warranty. Contact SKOPE for more information.

*Watermark approval is only applicable to Australian installations. Elsewhere, a suitable water filter must be used

